

Preparation of Hazard, Vulnerability & Risk Analysis atlas and report for the state of Himachal Pradesh

Building Vulnerability and Risk Assessment Composite Final Draft Report

(T6)

Prepared for



Disaster Management Cell, Department of Revenue
Government of Himachal Pradesh, Shimla

Prepared by



TARU Leading Edge Pvt. Ltd.
New Delhi and Ahmedabad, India

March 2015

VOLUME GUIDE

This series of reports present detailed technical and methodological documentation of the study entitled “Preparation of Hazard, Vulnerability & Risk Analysis Atlas and Report for the State of Himachal Pradesh” for DM Cell, Revenue Department, Himachal Pradesh.



Hazard Risk

This volume contains Technical papers on hazard risk assessment due to natural and man-made hazards within Himachal Pradesh as presented below.

1. Avalanche Hazard Risk
2. Climate Change & Flood Hazard Risk
3. Drought Hazard Risk
4. Earthquake Hazard Risk
5. Environmental & Industrial Hazard Risk
6. Forest Fire Hazard Risk
7. GLOF Hazard Risk
8. Landslide Hazard Risk



Vulnerability and Risk

This volume contains Technical papers on the Vulnerability and Risks to key elements at risk within Himachal Pradesh as presented below.

1. Socio-Economic Vulnerability and Risk
2. Building Vulnerability and Risk



Vulnerability and Risk

Building Vulnerability and Risk Assessment

Composite Final Draft Report

(T6)

Abstract

In recent past due to rapid growth of Indian cities, there is a tremendous increase on housing industry, especially in seismic Zone-IV & V. As most of these constructions are without earthquake resistant measures, the built environment in these zones has been found seismically vulnerable. Since Indian cities are built with varied varieties of building typologies, comprising of poorly designed and less maintained ones, the seismic safety of these constructions became the most challenging task. Seismic vulnerability is a measure of the seismic strength or capacity of a structure, hence it is found to be the main component of seismic risk assessment. Detailed seismic vulnerability evaluation is a technically complex and expensive procedure and can only be performed on a limited number of buildings. It is therefore very important to use simpler procedures that can help to rapidly evaluate the vulnerability profile of different types of buildings, so that the more complex evaluation procedures can be limited to the most critical buildings.

In the present study, 18721 buildings of different housing typologies in Himachal Pradesh had been surveyed. Out of 18721 buildings surveyed, Rapid visual screening Of 9099 buildings were done while photographic summary of 9622 buildings of similar characteristics were taken. Approximately 50 buildings are studied in detailed for which, detailed vulnerability assessment is carried out. In this report the main focus is on state of damage with respect to peak ground acceleration and RVS score. The same analysis is done for all five typologies of structures (Reinforced Concrete, Brick Masonry, Stone Masonry, Rammed Earth and Hybrid). For this purpose, numerical modeling using SAP and AEM are considered. The methodology of the numerical models is discussed in the following sections. Using energy approach, damage of buildings are evaluated both in X and Y directions. From the analysis, it is concluded that the rammed earth buildings are brittle when subjected to seismic forces on it. The buildings may collapse in moderate to high seismic zones as per Indian seismic standards. The RVS score of above buildings vary from 82 to 93.

Contents

GLOSSARY	1
1. Background:	3
2. History of Earthquakes in Himachal Pradesh:	4
3. Objective of the BVA Study:	6
4. Methodology:	7
4.1 Rapid Visual Screening:	8
4.2 Preliminary Vulnerability Assessment (PVA):	9
4.3 Detailed Vulnerability Assessment:	10
4.4 Limitations and Assumptions:	10
5. Building Typology in Himachal Pradesh:	11
5.1 Building Classification by Predominant Roof Material:	12
5.2 Building Classification by Predominant Wall Material:	14
5.3 Building Typology by combination of roof and wall material:	16

5.4 Traditional Building Typologies of Himachal Pradesh:	21
5.4.1 Dhajji Dewari:.....	21
5.4.2 Thatara House:.....	22
5.4.3 Kath Khuni Architecture:	22
6. Building Vulnerability in Himachal Pradesh-Key Aspects:	23
6.1 Non availability and high cost of construction material:.....	25
6.2 Non code compliance:	26
6.3 Level of workmanship:	27
6.4 Poor Construction Practices:.....	28
6.4.1 Hybrid Construction:	28
6.4.2 Pounding due to close proximity of two buildings:	29
6.4.3 Roof without waterproof solution:.....	30
6.4.4 Beam Column Junction:	30
6.4.5 Plan Irregularities:.....	31
6.5 Site Morphology and Local Soil Condition:	32
7. Rapid Visual Screening (RVS).....	33
7.1 Design of Integrated RVS Format:	34
7.2 Development of RVS reference guide and Field guide book:.....	35
7.3 Design of integrated RVS format for tablet computers:.....	35
7.4 Training of Surveyors:	36
7.5 Creation of Inventory of Building Vulnerability Database and Data Verification: ..37	
7.5.1 Creation of Inventory of Building Vulnerability Database:	38
7.5.2 Mechanism for Verification of Building Vulnerability Data:	40
7.6 RVS scoring methodology:.....	41
7.7 Parameters for performance score evaluation:	44
7.7.1 Number of Floors	44
7.7.2 Structural Irregularities	44
7.7.3 Heavy Overhangs:.....	45
7.7.4 Re-entrant Corners:	46
7.7.5 Local Soil Conditions:	47
7.7.6 Pounding:	47
7.7.7 Diaphragm Action:.....	47
7.7.8 Soft/weak stories:.....	47
7.7.9 Short Column Failure:.....	48
7.7.10 Frame Action:.....	48
7.7.11 Falling Hazards:	48
7.7.12 Vertical Irregularities:.....	49
7.7.13 Apparent Quality:	49
7.7.14 Wall opening:	50
7.7.15 Horizontal band:	50
7.8 Rapid Visual Screening of Buildings:.....	50
7.8.1 Educational Institute:	57
7.8.2 Health Institutions:	59
7.8.3 Government Buildings:.....	61
7.8.4 Cowsheds:.....	62
7.9 Building Vulnerability Distribution at District Level in the State:	64
7.9.1 Brick Masonry buildings:	65
7.9.2 Stone Masonry buildings:.....	65
7.9.3 Rammed earth buildings:.....	66
7.9.4 Hybrid buildings:	66
7.9.5 RC Frame Buildings:	67

8. Preliminary Vulnerability Analysis	69
8.1 Methodology:	69
8.2 Non-destructive Testing (NDT):.....	71
8.2.1 Rebound Hammer Test:	71
8.2.2 Ultrasonic Pulse Velocity Method:.....	73
8.2.3 Rebar Locator Test:	74
8.3 Preliminary Vulnerability Assessment of buildings:.....	75
9. Detailed Vulnerability Analysis:	80
9.1 Methodology for numerical modelling of buildings:	81
9.1.1 Applied Element Method (AEM):.....	81
9.1.2 Finite Element Method (FEM):	84
9.1.3 Modelling of Brick Masonry Building:.....	85
9.2 Detailed Analysis of Building:	88
9.2.1 Geometry Details:	88
9.2.2 Material Properties:.....	95
9.2.3 Loading Pattern.....	95
9.3 Pushover Analysis:	96
9.4 Fragility Curve:	100
9.5 Damage of the Building for different return periods of earthquake:.....	103
9.6. Life Loss Estimation due to Earthquake:	113
9.7 Economic Loss Estimation due to Building Damage:.....	117
10. Conclusions and Recommendations:	119
11. References:	121
Annexure 1: Team for Building Vulnerability Assessment.....	125
Annexure 2: List of Surveyors.....	127
Annexure 3: Details of EERC, IIT Hyderabad team for NDT	128
Annexure 4: Integrated Rapid Visual Screening Format for Buildings in H.P.....	129
Annexure 5: Datasheet for Economic Loss Estimation	139
Annexure 6: Sample Of RVS Score Calculation For Each Building Typology	142
Annexure 7: Number of Buildings Damaged under Predominant Building Typology due to Earthquake of different Return Period.....	152

List of Tables

Table 1: Distribution of major earthquakes in HP from 1900-1963 ()	4
Table 2: District-wise area under seismic zones V and IV of HP and district-wise number of earthquakes from 1800-2008 (>M4.0).....	5
Table 3: Distribution Of Households (%) In Districts Of Himachal Pradesh By Predominant Roof Material	13
Table 4: Distribution Of Households In Districts Of Himachal Pradesh By Predominant Wall Material	15
Table 5: Predominant building typology in districts of H.P.	16
Table 6: Percentage Of Predominant Building Typology In Himachal Pradesh	20
Table 7: Traditional Construction Practice In Different Districts Of Himachal Pradesh	21
Table 8: Distribution Of Houses By Predominant Materials Of Roof And Wall And Level Of Damage Risk In Himachal Pradesh	24
Table 9: Integrated RVS Process	34
Table 10: Different Steps of Data Collection Using Tablet Computer Based RVS Format	38
Table 11: Base Scores (BS) and Vulnerability Scores (VS) for RC Frame Buildings in India	42
Table 12: Vulnerability Scores Modifiers (VSM) for RC Frame Building in India	43
Table 13: Base Scores (BS) and Vulnerability Scores (VS) of Masonry Buildings in India.....	43
Table 14: Vulnerability Scores Modifiers (VSM) for Masonry Buildings in India	44
Table 15: Number of Buildings surveyed during RVS	52
Table 16: Type of Construction in Educational Institute	57
Table 17: Type of Education Institute and their Age of Construction (Sample: 578 buildings) ...	57
Table 18: Vulnerability of Educational Institute with respect to their age of construction.....	58
Table 19: Vulnerability of Different type of Educational Institute	58
Table 20: Building typology of Health Institutions.....	59
Table 21: Velocity Criterion For Concrete Quality Grading	74
Table 22: District Wise Distribution Of Buildings For Ndt Testing.....	75
Table 23: Distribution Of Buildings For NDT Testing On The Basis Of Type Of Construction And Their Use	75
Table 24: Building Details collected during Preliminary Vulnerability Assessment	78
Table 25: General information and geometry details of RC buildings from 1 to 4	88
Table 26: General information and geometry details of RC buildings from 5 to 8	89
Table 27: General building information of brick masonry buildings.....	90
Table 28: Geometry details of all brick masonry buildings	91
Table 29: Geometry details of stone masonry buildings.....	92
Table 30: Geometry details of rammed earth buildings.....	93
Table 31: Structural and geometry details of hybrid building 1 and 2	95
Table 32: Classification of Damage Grade	104
Table 33: Type of Buildings (IS 1893: 2002)	104
Table 34: MSK-64 earthquake intensity scale adopted in India (IS:1893-2002).....	104
Table 35: Estimated Number of Buildings in Himachal Pradesh	105
Table 36: Percentage of Building Damage due to Earthquake of 100 year return period	106
Table 37: Percentage of Building Damage due to Earthquake of 200 year return period	106
Table 38: Percentage of Building Damage due to Earthquake of 475 year return period	107
Table 39: Percentage of Building Damage due to Earthquake of 2475 year return period	107
Table 40: Percentage of Buildings Falling under Different Damage Category for Earthquake of 475 Return Period.....	108

Table 41: Proportion of damage of buildings in the state of HP for MSK VIII or seismic zone IV	111
Table 42: Proportion of damage of buildings in the state of HP for MSK IX or seismic zone V ..	111
Table 43: Summary of Earthquake Loss in India from 1900 to 2014	114
Table 44: Assumed Death Rates for Earthquake	114
Table 45: Estimated Number of Deaths from Earthquake: Mid Night Scenario.....	115
Table 46: Estimated Number of Deaths from Earthquake: DayTime Scenario	116
Table 47: Average built up area and Cost of Building per square meter	117

List of Figures

Figure 1: Earthquake Hazard Map of H.P. (Source: Vulnerability Atlas of India, 2 nd edition, BMTPC 2006).....	3
Figure 2: Main Earthquake Events in Himachal Pradesh and surrounding region (250A.D. -2009 A.D.) (TARU Analysis 2013)	6
Figure 3: Building Vulnerability Assessment Process (TARU Analysis, 2013)	7
Figure 4: Flow Chart of Building Vulnerability Assessment Process (TARU Analysis, 2013).....	8
Figure 5: Flow Chart of Preliminary and Detailed Vulnerability Assessment (TARU Analysis, 2013)	9
Figure 6: District wise Census House distribution in H.P.(Census of India 2011; TARU Analysis 2013)	11
Figure 7: Percentage of Census Houses in Rural and Urban part of Districts in H.P. (Census of India 2011; TARU Analysis 2013).....	12
Figure 8: Households Distribution in Himachal Pradesh by Predominant Roof Material (Census of India 2011; TARU Analysis 2013).....	12
Figure 9: Distribution of Households by roof material at district level in Himachal Pradesh (Census of India 2011; TARU Analysis 2013)	13
Figure 10: Distribution of Households by roof material in Urban and Rural Himachal Pradesh (Census of India 2011; TARU Analysis 2013)	14
Figure 11: Distribution of Houses by predominant wall material in Himachal Pradesh (Census of India 2011; TARU Analysis 2013).....	14
Figure 12: Distribution of Households by roof material at district level in Himachal Pradesh (Census of India 2011; TARU Analysis 2013)	15
Figure 13: Distribution of Houses by wall material in Urban and Rural parts of Himachal Pradesh (Census of India 2011; TARU Analysis 2013)	15
Figure 14: Brick Masonry Census Houses with Predominant Roof Material	18
Figure 15: Stone Masonry (with mortar) Census Houses with Predominant Roof Material	18
Figure 16: Stone Masonry (without mortar) census houses with Predominant Roof Material....	19
Figure 17: Census Houses made of Mud/Unburnt Brick Wall and Predominant Roof Material ..	19
Figure 18: RC Frame Census Houses with Predominant Roof Material.....	20
Figure 19: Dhajji Dewari Type House (Shimla, 13 th November 2013)	21
Figure 20: Thathara House (Bharmour, Dist. Chamba, 20 th October 2013).....	22
Figure 21: Kath Khuni Architecture (Village: Dharmaling, Kinnaur, 29 th September 2013)	23
Figure 22: PWD office building in Hamirpur (Hamirpur, 23 rd August 2013)	27
Figure 23: Brick Masonry construction of Anganwadi (Bhoranj, Hamirpur, September 2013)...	27
Figure 24: Hybrid Construction (RC Frame and Brick Masonry) in Kangra.....	28
Figure 25: Hybrid Construction (Stone masonry and brick masonry)	29
Figure 26: Possible location of occurrence of pounding	30
Figure 27: Water seepage problem in the roof and wall (Hamirpur, 16 th December 2013).....	30
Figure 28: Wrong Practice of Beam Column Junction	31
Figure 29: Re-entrant corner in L shape building (Kangra, 17 th December 2013).....	32
Figure 30: Construction of building on sloping site	33
Figure 31: Reference Manual and Field Guide Book developed for RVS (TARU, 2013)	35
Figure 32: ODK (Open data Kit) Framework (Carl Hurtung 2010).....	36
Figure 33: Field Training of Surveyors for BVA Survey (Hamirpur. 16-17 th August 2013).....	37
Figure 34: Data Collection on server	39
Figure 35: Data Download option from server on user need base.....	39

Figure 36: Visualization of selected parameter of collected building data directly on web	40
Figure 37: Map showing the locations of buildings for RVS	40
Figure 38: Structural irregularities are present in the building at Kangra district	45
Figure 39: Heavy overhangs are present on the top of structure at Kangra district	46
Figure 40: Re-entrant corners in buildings	46
Figure 41: Falling hazards in a building	49
Figure 42: Number of Buildings surveyed during RVS (TARU Analysis 2014)	51
Figure 43: Building surveyed by number of storey	51
Figure 44: Number of Buildings surveyed in RVS.....	52
Figure 45: Engineered/ Non-engineered Building Construction in H.P. (Sample Size: 9099 buildings)	52
Figure 46: Trend of Building Typology in Different Age of Construction (Sample taken: 9099 buildings)	54
Figure 47: Brick Masonry Buildings of different age of construction	54
Figure 48: Stone Masonry Buildings of different age of construction.....	55
Figure 49: RC Frame Buildings in Different Age of Construction	56
Figure 50: Rammed Earth Buildings in Different Age of Construction	56
Figure 51: Hybrid Buildings in Different Age of Construction.....	57
Figure 52: Building Typology of Educational Institute	58
Figure 53: Percentage of Educational Buildings under different level of Vulnerability (Sample : 578 buildings).....	59
Figure 54: Building Typology of Health Institutions	60
Figure 55: Vulnerability Status of Health Institutions under different age of construction	61
Figure 56: Government Buildings surveyed during RVS.....	61
Figure 57: Vulnerability Status of Government Buildings	62
Figure 58: Cowsheds made of unburnt brick/mud wall and slate roof	63
Figure 59: Building Typology of Cowshed.....	63
Figure 60: Mortar used in the Construction of Cowsheds	64
Figure 61: Vulnerability of Cowsheds in Different Districts of H.P.	64
Figure 62: Normal distribution curve for brick masonry buildings through RVS	65
Figure 63: Normal distribution curve for Stone Masonry buildings through RVS.....	66
Figure 64: Normal distribution curve for Rammed earth buildings through RVS.....	66
Figure 65: Normal distribution curve for Hybrid buildings through RVS	67
Figure 66: Normal distribution curve for RC buildings through RVS	67
Figure 67: Normal Distribution Curve for All Building Typologies.....	68
Figure 68: Normal distribution curve for RC buildings & Brick Masonry Buildings	68
Figure 69: Normal distribution curve for Stone Masonry and Rammed Earth Buildings	68
Figure 70: Normal distribution curve for Hybrid Buildings and Typology wise	69
Figure 71: Chart of correlation between rebound number and cube compressive strength (Source: www.construction.org).....	72
Figure 72: Various Transmission modes for Ultrasonic Pulse Velocity Method (Source: CPWD 2007)	74
Figure 73: Rebound Hammer Test (Hamirpur, 15th December 2013)	76
Figure 74: Ultrasonic Pulse Velocity Method (Kangra, 17th December 2013)	77
Figure 75: Preparation of instrument before Ultrasonic Pulse Velocity Method (Kangra, 17th December 2013).....	77
Figure 76: Rebar Locator Test (Kangra, 17th December 2013)	78
Figure 77: Overview of numerical techniques	81

Figure 78: Modelling of structure in AEM and element shape, contact point and dof	82
Figure 79: Material models for concrete and steel	82
Figure 80: (a) Principal Stress determination and (b) Redistribution of spring forces at element edges.....	83
Figure 81: Modified Takeda model	85
Figure 82: Masonry discretization (Pandey et al, 2004)	86
Figure 83: (a) Cohesion degradation,(b) Bond degradation (Pandey et al, 2004).....	87
Figure 84: Failure criteria for joint spring (Sutcliffe et al, 2001)	87
Figure 85: Hardening and softening applied for joint spring in compression cap (BishnuPandey et al, 2004)	88
Figure 86: General View of RC Buildings.....	90
Figure 87: General View of brick masonry Buildings	92
Figure 88: General View of stone masonry Buildings	93
Figure 89: General View of rammed earth Buildings	94
Figure 90: General View of hybrid buildings	95
Figure 91: Base shear vs drift ratio for rammed earth building in X direction	97
Figure 92: Base shear vs drift ratio for rammed earth building in Y direction	97
Figure 93: Base shear Vs Roof Displacement for RC Frame Building	98
Figure 94: Base Shear Vs Interstorey Drift for Brick Masonry Building in X and Y Direction	98
Figure 95: Base shear vs. drift ratio for stone masonry buildings	99
Figure 96: Base Shear Vs Drift Ratio for Rammed Earth Building	99
Figure 97: Base shear vs. drift ratio for hybrid buildings	100
Figure 98: Schematic diagram represents Base shear vs roof displacement of building for calculating damage.....	101
Figure 99: Generalized state of damage for different typology of w.r.t RVS scores.....	102
Figure 100: Earthquake Damage to Stone Masonry Residential Building (475 years Return Period).....	109
Figure 101: Damage state of all type of buildings of HP subjected to 0.24 g.....	110
Figure 102: Damage state of all type of buildings of HP subjected to 0.36 g.....	110
Figure 103: Damage state of RC buildings in all districts of HP subjected to 0.24 g & 0.36g.....	112
Figure 104: Damage state of brick masonry buildings in all districts of HP subjected to 0.24 g & 0.36g.....	112
Figure 105: Damage state of stone masonry buildings in all districts of HP subjected to 0.24 g & 0.36g.....	113
Figure 106: Damage state of rammed earth buildings in all districts of HP subjected to 0.24 g & 0.36g.....	113
Figure 107: Damage state of hybrid buildings in all districts of HP subjected to 0.24 g & 0.36g.....	113
Figure 108: Number of Casualties due to Earthquake of different Return Period (Midnight Scenario)	116
Figure 109: Number of Casualties due to Earthquake of different return period (Daytime Scenario)	117
Figure 110: Economic Loss to Buildings due to Earthquake of different Return Period	119

GLOSSARY

Hazard: A dangerous phenomenon, substance, human activity or condition that may cause loss of life, injury or other health impacts, property damage, loss of livelihoods and services, social and economic disruption, or environmental damage. (UNISDR 2009)

Disaster: A serious disruption of the functioning of a community or a society involving widespread human, material, economic or environmental losses and impacts, which exceeds the ability of the affected community or society to cope using its own resources. (UNISDR 2009)

Vulnerability: The characteristics and circumstances of a community, system or asset that make it susceptible to the damaging effects of a hazard. (UNISDR 2009)

Disaster Risk: The potential disaster losses, in lives, health status, livelihoods, assets and services, which could occur to a particular community or a society over some specified future time period. (UNISDR 2009)

Mitigation: The lessening or limitation of the adverse impacts of hazards and related disasters. (UNISDR 2009)

Natural Hazard: Natural process or phenomenon that may cause loss of life, injury or other health impacts, property damage, loss of livelihoods and services, social and economic disruption, or environmental damage. (UNISDR 2009)

Households: A 'household' in the census is defined as a group of persons who normally live together and take their meals from a common kitchen unless the exigencies of the work prevent any of them doing so. The person in household may be related or unrelated or a mix of both. However, if a group of persons live in a census house but do not take their meal from the same kitchen, they are not considered as a household. Each person is treated as a separate household. (Census of India, 2011)

Census House: A 'Census House' is a building or part of a building used or recognized as a separate unit because of having a separate main entrance from the road or common courtyard or staircase etc. It may be occupied or vacant. It may be used for a residential or non-residential purpose or both. (Census of India, 2011)

Urban: Urban areas are those places which qualify the following criteria: (Census of India, 2011)

- a.) All places with a municipality, corporation, cantonment board or notified town area committee, etc. (known as Statutory Town)
- b.) All other places which satisfied the following criteria (known as Census Town):
 - A minimum population of 5,000;
 - At least 75 per cent of the male main workers engaged in non-agricultural pursuits; and
 - A density of population of at least 400 per sq. km.

Rural: All other areas which do not qualify under the urban areas, they are considered as rural areas. (Census of India, 2011)

Critical Facilities: The primary physical structures, technical facilities and systems which are socially, economically or operationally essential to the functioning of a society or community, both in routine circumstances and in the extreme circumstances of an emergency. They include such things as transport systems, air and sea ports, electricity, water and communications systems, hospitals and health clinics, and centers for fire, police and public administration services. (UNISDR 2009)

Rapid Visual Screening (RVS): RVS is a form of survey to identify the buildings which are expected to be more vulnerable under an earthquake. It is used to prioritize the building in a jurisdiction for further evaluation and retrofit for seismic forces. (CPWD 2007)

Non Destructive Testing (NDT): The test of component of a building which does not cause any damage. (CPWD 2007)

Load Path: A course along which the seismic inertia forces are transferred from the superstructure to the foundation and finally to the ground. (CPWD 2007)

Knowledge Factor: A factor to represent the uncertainty of the available information about the structural configuration or present condition of the materials or components of existing building. (CPWD 2007)

Epicenter: It is the point on the earth's surface directly above the hypocenter. The epicenter is described as the location of the point of fault rupture on the map in terms of latitude and longitude

Storey Drift: It is the displacement of one level relative to the other level above or below. (IS 1893 (Part 1):2002)

1. BACKGROUND:

The northwest Himalayas have witnessed a large number of earthquakes in the last century. The most devastating one of these was Kangra earthquake of 4th April 1905. Kangra earthquake took the toll of 20,000 lives and damaged most of the buildings (BMTPC, 1999). Dharamsala earthquake of 26th April 1986 and Chamba earthquake of 24th March 1995 caused extensive damage to buildings (Source: HPSDMA website). Himachal falls under seismic zone IV and V which is highly prone to earthquake. Zone V is defined as very high damage risk zone (MSK IX or more) and zone IV is defined as high damage risk zone (MSK VIII). Chamba, Kangra, Bilaspur, Kullu and Manali fall in seismic zone V. Most of the earthquake occurred in the last century were located along three major thrust zone i.e. Main

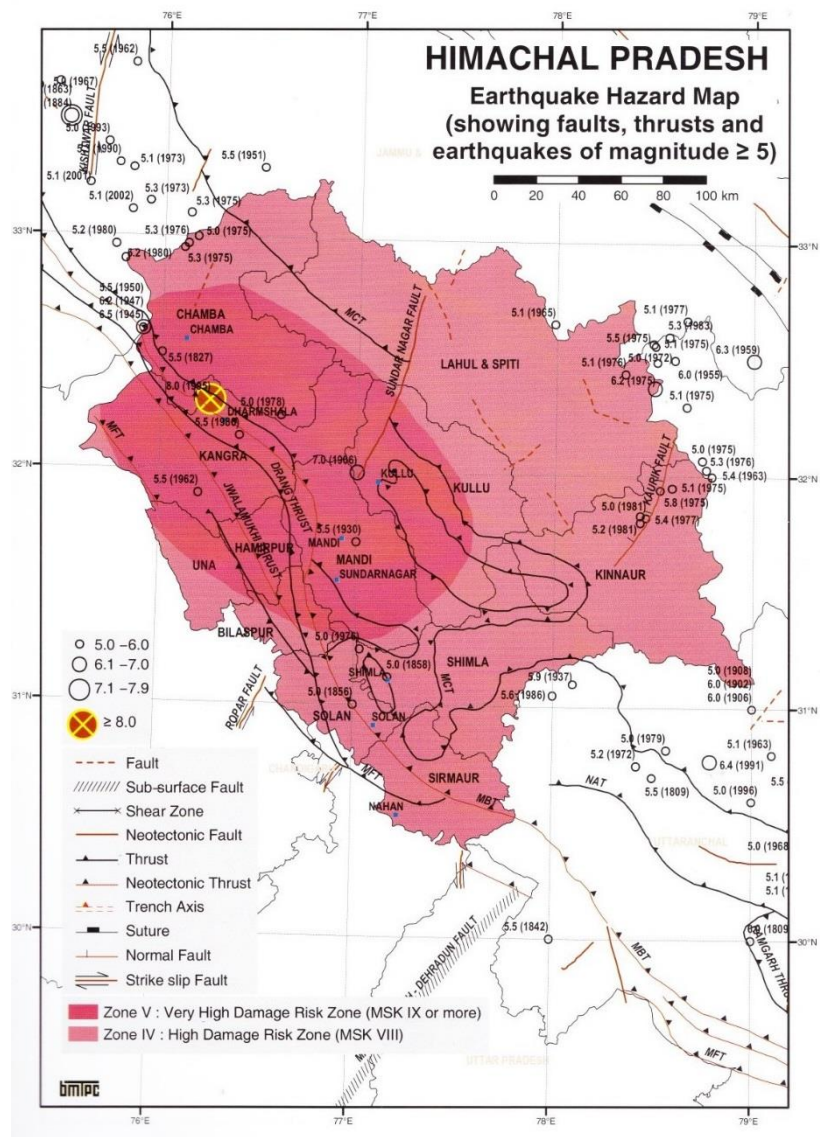

Figure 1: Earthquake Hazard Map of H.P. (Source: Vulnerability Atlas of India, 2nd edition, BMTPC 2006)

Boundary Thrust (MBT), Main Central Thrust (MCT) and Central Counter Thrust (CCT) (Figure 1). The state of Himachal Pradesh is exposed to a range of natural, environmental and man-made hazards. Main hazards consist of earthquakes, landslides, flash floods, snow storms, avalanches, GLOF, droughts, dam failures, fires, forest fire, lightning etc.

Enormous economic losses caused due to natural disasters such as earthquakes, floods, landslide, avalanche, etc., erode the development gain and bring back economy a few years ago. Most of the fatalities and economic losses occur due to the poor construction practices, lack of earthquake resistant features of the buildings and low awareness about disasters among people. In order to estimate and quantify risk, it is necessary to

carry out the vulnerability assessment of the existing building stocks and lifeline infrastructure.

Building Vulnerability assessment is carried out in three stages i.e. Rapid Visual Screening (RVS), Preliminary Vulnerability assessment (PVA) and Detailed Vulnerability Assessment (DVA). As detailed vulnerability assessment of each single building is a very expensive and time consuming process hence only few buildings of different building typology are selected for PVA on the basis of the vulnerability score. This scoring will be supportive in making a decision that whether further stage of vulnerability assessment and retrofitting is required or not. Finally fragility curve will be developed for available building typology as per census 2011.

2. HISTORY OF EARTHQUAKES IN HIMACHAL PRADESH:

The beginning of the 20th century was marked by one of the most deadly and devastating disasters of all time in India. An earthquake of 7.8 magnitude having epicenter at 32° 16' N and 77° 15' E that occurred on 4 April 1905, caused widespread damages in the state and other parts of north-west India. Another high intensity earthquake of magnitude above 7 on the Richter Scale occurred on 28 February 1906 at 32° 00' N and 77° 00' E in Kullu valley. The other high-intensity earthquakes (magnitude above 6) occurred in the years 1914, 1945 and 1947. There were four earthquakes of medium intensity (magnitude 5–5.9) that occurred in 1930, 1950, 1962 and 1963. From 1964 to 2008, 520 earthquakes of varying magnitude occurred in Himachal Pradesh (table 1). This seismic event of magnitude 6.2 on Richter scale was centred in Kinnaur on 19 January 1975 at 32° 22' N and 78° 30' E wherein 42 people died and 40 were severely injured. The last damaging earthquake in the State measuring 5.5 on the Richter scale occurred on 26 April 1986 in Dharamsala area.

The entire state is at risk of being affected by a severe seismic event. About 32% of the total geographical area of Himachal Pradesh falls in the very high seismic zone V, while the rest (68%) lies in the high seismic zone IV. Ten out of 12 districts fall in the very high seismic zone. Three districts have over 90% of their geographical area prone to very high seismicity. Two districts have more than 50% of the geographical area with the severest seismic intensity: Chamba (53.2%), and Kullu (53.1%). During 1800–2008, about 70% of earthquakes occurred in three districts, namely, Chamba, Lahul and Spiti, and Kinnaur. Three districts, Solan, Hamirpur and Bilaspur, have less than 1% concentration, whereas in Una district, no earthquake has ever been recorded during this period (Chandel et al., 2010). Table 2 shows the distribution of seismic area of HP under IV and V and number of occurrence of earthquakes (>M4.0). Figure 2 shows the main earthquake events in Himachal Pradesh and surrounding region from 250 A.D. to 2009 A.D.

Table 1: Distribution of major earthquakes in HP from 1900-1963 ()

S.No	Date	Magnitude	District
1.	04 April 1905	8.0	Kangra

S.No	Date	Magnitude	District
2.	28 February 1906	7.0	Kullu
3.	09 October 1914	6.1	Chamba
4.	11 May 1930	5.5	Mandi
5.	22 June 1945	6.5	Chamba
6.	10 July 1947	6.2	Chamba
7.	12 August 1950	5.5	Chamba
8.	15 September 1962	5.5	Kangra
9.	12 April 1963	5.4	Kinnaur
10.	12 November 1963	4.6	Kinnaur

Source: Chandel et al., 2010

Table 2: District-wise area under seismic zones V and IV of HP and district-wise number of earthquakes from 1800-2008 (>M4.0)

S.No	District	Area under Seismic Zone V (%)	Area under Seismic Zone IV (%)	Number of Earthquakes
1.	Kangra	98.8	1.2	39
2.	Mandi	97.4	2.6	53
3.	Hamirpur	90.9	9.1	2
4.	Chamba	53.2	46.8	186
5.	Kullu	53.1	46.9	19
6.	Una	37.0	73.0	0
7.	Bilaspur	25.3	74.7	1
8.	Lahul and Spiti	2.14	97.86	99
9.	Shimla	0.38	99.62	49
10.	Solan	1.06	98.94	4
11.	Sirmaur	--	100	8
12.	Kinnaur	--	100	93

Source: Chandel et al., 2010

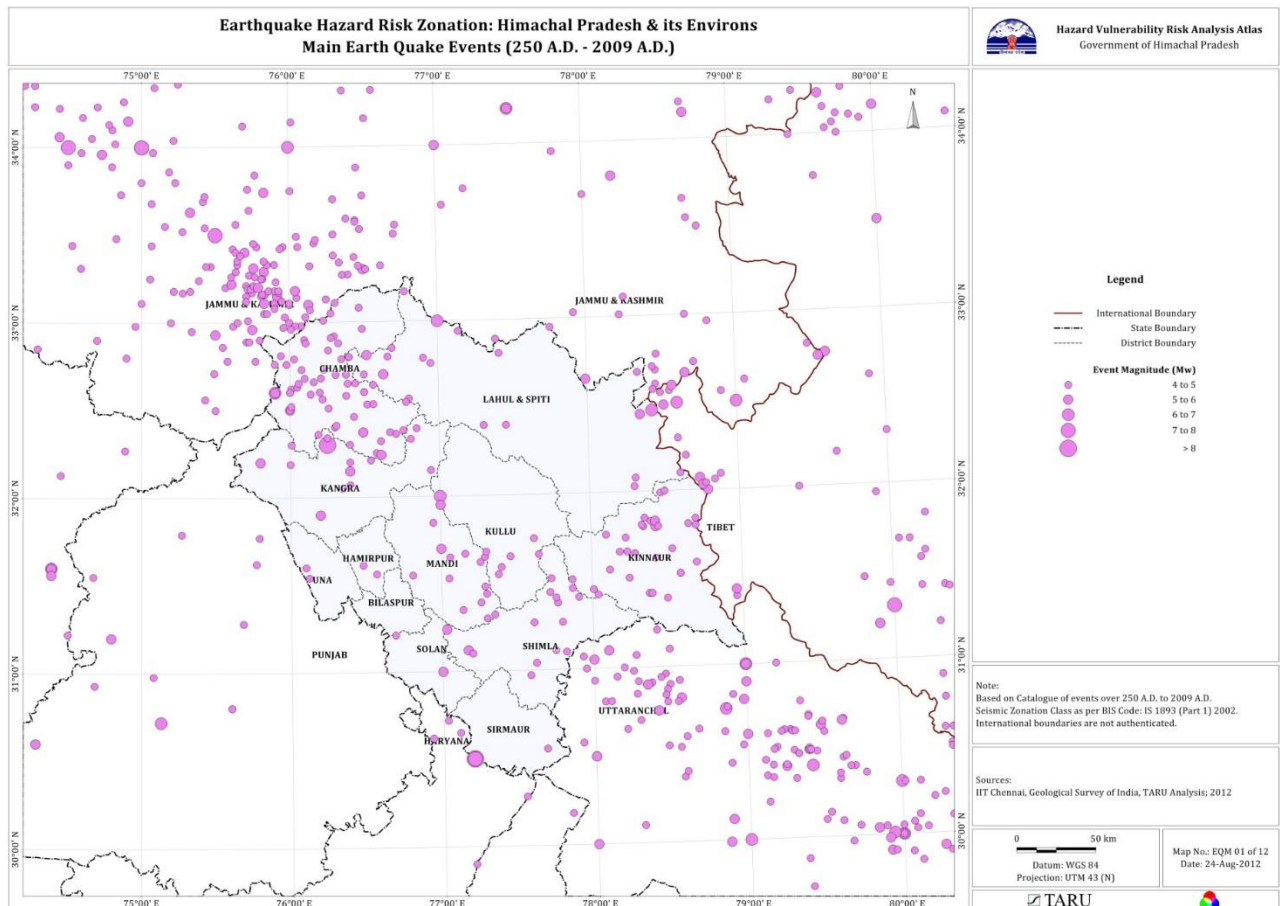

Figure 2: Main Earthquake Events in Himachal Pradesh and surrounding region (250A.D. -2009 A.D.) (TARU Analysis 2013)

3. OBJECTIVE OF THE BVA STUDY:

Building vulnerability assessment is required to assess the condition of building stock present across the state. This study is undertaken to identify the buildings and critical infrastructure which require special attention in order to make them more resistant against the natural disasters.

The specific objectives of this study are:

- Classification of Building Typology of the existing building stock of Himachal Pradesh
- Building Vulnerability Assessment Survey of 20,000 buildings
- Inventory of buildings surveyed during RVS
- Preliminary vulnerability assessment (PVA) of selected buildings
- Detailed vulnerability assessment (DVA) Of selected buildings
- Development of vulnerability functions (fragility curve) for defined building typologies in census 2011
- Estimation of economic losses in buildings
- Production of building vulnerability maps at block level

4. METHODOLOGY:

Building vulnerability assessment (BVA) is a three stage process. It includes rapid visual screening (RVS) of buildings, preliminary vulnerability assessment (PVA) and detailed vulnerability assessment (DVA). DVA will be undertaken for selected structures. Figure 3 describes the different activities to be carried out under each stage of BVA.

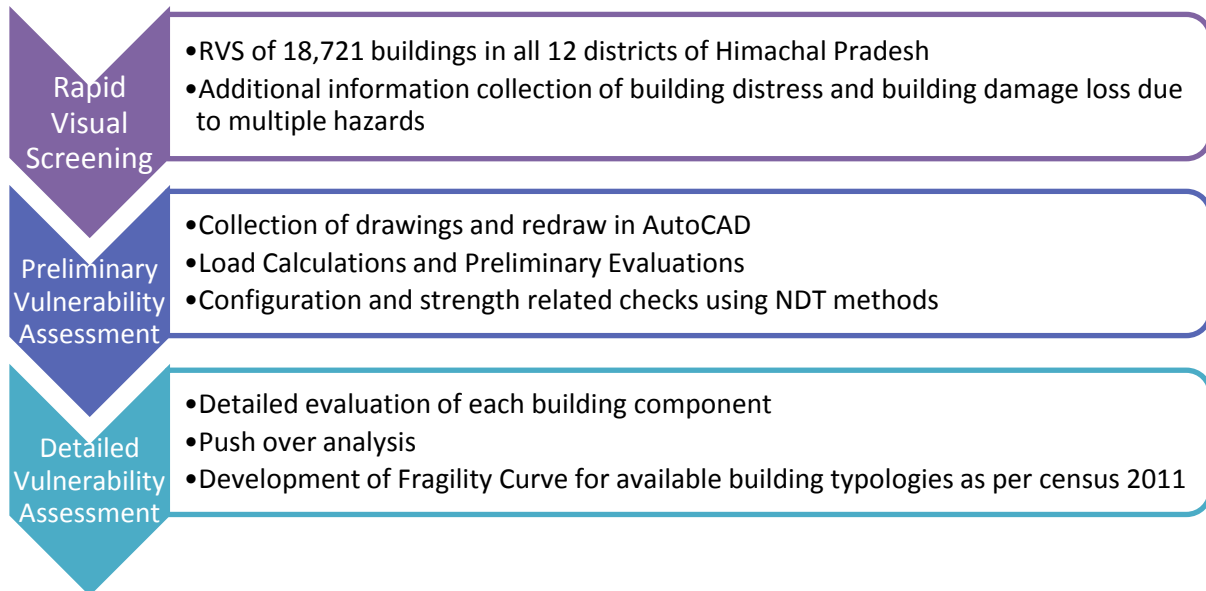

Figure 3: Building Vulnerability Assessment Process (TARU Analysis, 2013)

Initially housing census data (2011) of Himachal Pradesh was analyzed to get the existing predominant building typology. Percentage of households for predominant roof and wall type combination were calculated in each district. Number of different building types to be surveyed in each district were derived on the basis of this analysis. Number of buildings to be surveyed in each town/ district during RVS was based on the total number of existing building in those area. It helped in arriving a good sample of buildings for RVS across the state. As Kangra is the largest district of H.P., maximum number of buildings were surveyed here and lowest sample of buildings was taken from Lahul & Spiti district due to very less population and buildings in that region.

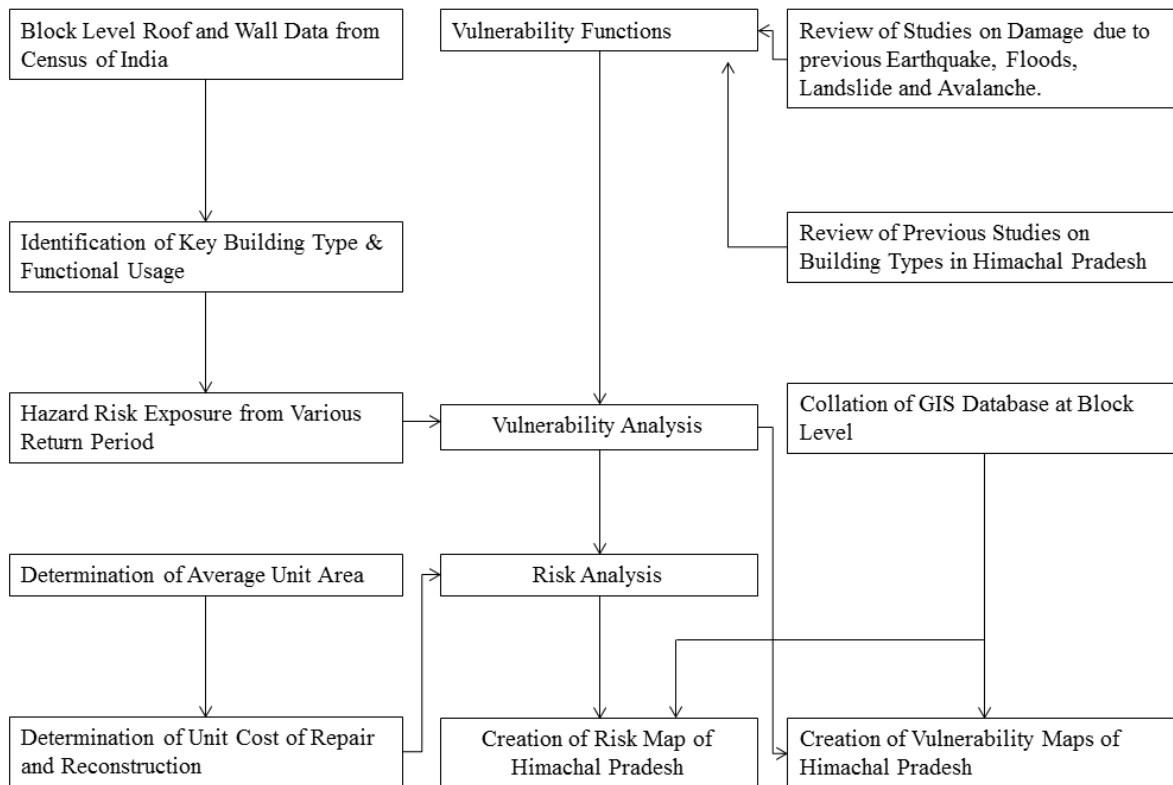

Figure 4: Flow Chart of Building Vulnerability Assessment Process (TARU Analysis, 2013)

4.1 Rapid Visual Screening:

RVS methodology was first developed by “Applied Technology Council” in the late 1980’s and published in FEMA 154 in 1988. RVS format was first time introduced for masonry buildings in Indian building code in 2009 i.e. IS 13935:2009 “Seismic Evaluation, Repair and Strengthening of Masonry Buildings - Guidelines”. This RVS format was designed for earthquake.

RVS is a form of survey to identify the buildings which are expected to be more vulnerable under an earthquake. It is used to prioritize the buildings in a jurisdiction for further evaluation and retrofit for seismic forces (CPWD 2007). RVS is designed to evaluate the primary lateral load resisting system and to identify the building attributes that modify the seismic performance of the lateral load resisting system along with the non-structural components. A building may require 15 to 30 minutes for RVS depending upon the size of the building. Data collection and decision making process will occur at the building site.

HVRA initiative in H.P. takes into account the multiple natural hazards (earthquake, flood, landslide, avalanche, fire etc.). An integrated RVS is needed to evaluate the vulnerability of the buildings for multiple hazards. For this project, RVS will be an inbuilt section of the whole building vulnerability assessment process.

4.2 Preliminary Vulnerability Assessment (PVA):

Preliminary vulnerability assessment (PVA) is done after getting the building data from RVS. RVS scoring is done to classify the building vulnerability. PVA involves the analysis of building data obtained from RVS and configuration and strength related checks. Buildings were selected from all three categories of vulnerability i.e. low, medium and high. Non-destructive testing (NDT) was performed on the selected structures based on the vulnerability score to collect the material characteristics.

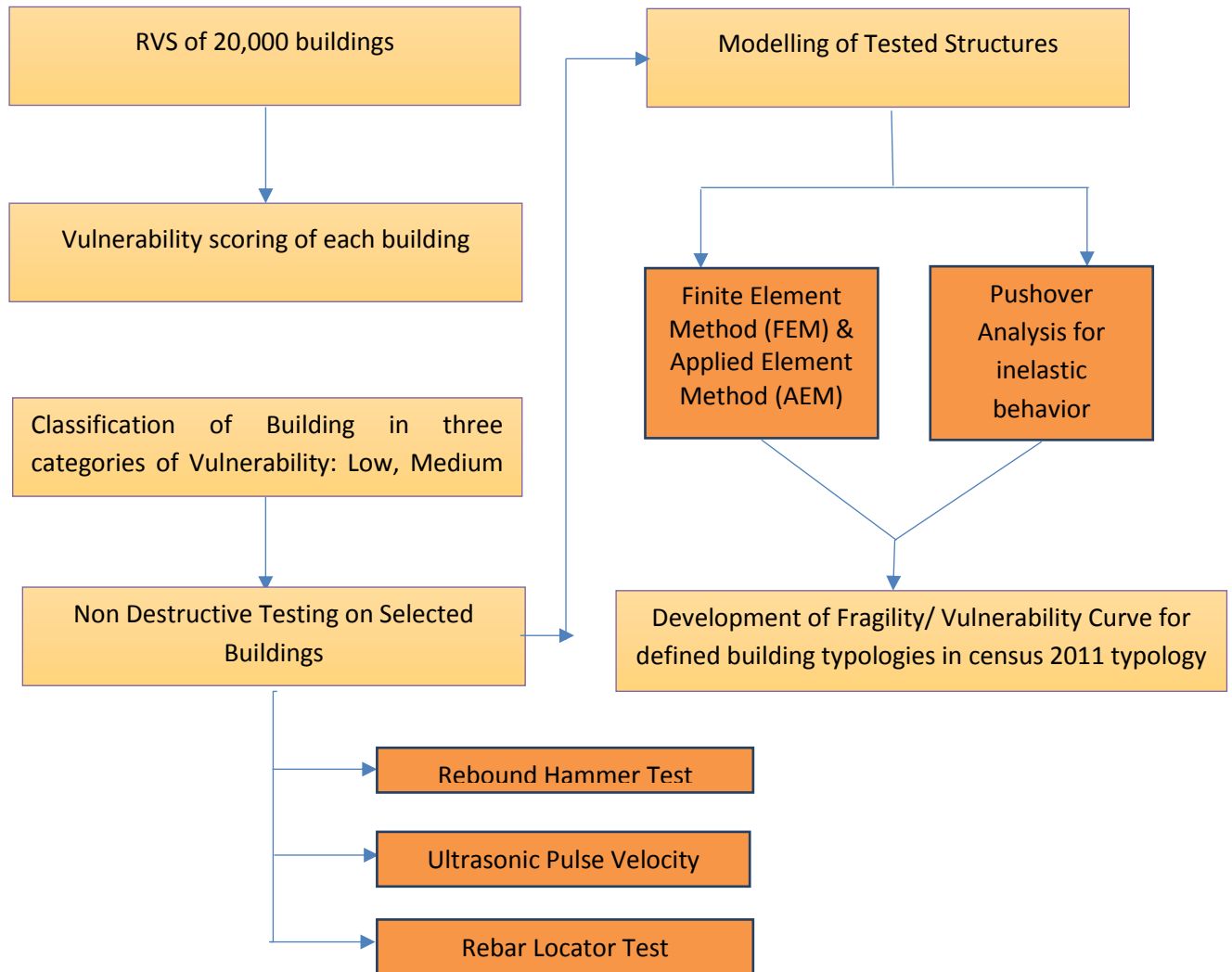

Figure 5: Flow Chart of Preliminary and Detailed Vulnerability Assessment (TARU Analysis, 2013)

PVA involves the following tasks:

- Collection of drawings and redraw in AUTOCAD (if possible)
- Identify the size of all columns and beams
- Load Calculations
- Preliminary Evaluation
- Configuration related Checks
- Strength related Checks

4.3 Detailed Vulnerability Assessment:

Detailed vulnerability assessment (DVA) involves the modelling of selected buildings using both SAP 2000 software and applied element method (AEM) to study the behaviour of buildings under different intensity of earthquake. Pushover analysis is done to simulate the inelastic behaviour of structures for a more realistic collapse mechanism. Pushover analysis is a type of nonlinear static analysis where the magnitudes of the lateral loads are incrementally increased, maintaining a predefined distribution pattern along the height of the building, until a collapse mechanism develop (CPWD 2007). Finally fragility curve or vulnerability function will be defined for most predominant building typologies as per the census 2011. The fragility curve is the graph between seismic ground acceleration in 'g' and damage. This relationship will estimate loss for different categories of buildings and intensities of earthquakes.

4.4 Limitations and Assumptions:

The analysis has been constrained by a number of limitations in the dataset and few assumptions were made in assessing the building damage.

- The analysis has been done on the Census 2011 housing and population data as this is latest information available.
- Maps are developed using tehsil as the smallest unit instead of block unit. Final maps are produced for 109 tehsil mentioned in Census 2001 data instead of 117 tehsils as per Census 2011 data as there was no new administrative map available defining block or tehsil boundary.
- Housing data of Census 2011 is only available in terms of number of household or census houses. Number of buildings were estimated by assuming that number of buildings surveyed in tehsils represent the universal sample of the total building stock.
- Size of census house is taken as 4.5 for calculating the number of buildings.
- For calculating the number of buildings for earthquake damage, extrapolation of data at tehsil level is done by taking the assumption that peak ground acceleration (PGA) will not vary significantly within tehsil area and other buildings were also constructed in a similar fashion as the surveyed one.
- Building types have been defined on the basis material of construction of wall as roof do not contribute in resisting the lateral forces developed due to earthquake although damage/ casualty rate may vary with different roof types. Collapse of heavier roof is more dangerous to human life than the lighter roof.
- Repair and loss estimates for particular building types are not available in Himachal Pradesh. Hence, fragility curves have been utilized directly to estimate number of casualty and economic losses.
- Knowledge factor was introduced into the analysis to represent the uncertainty about the reliability of the available information about the structural configuration and present condition of materials and components of the existing building.

- Hybrid buildings analysis have their own limitations in modelling. There is no uniform method/ modelling technique available for all kind of hybrid buildings as each type of building is different to the other one. This category will be classified as hybrid and other types of buildings. Buildings falling under category OTHERS (wall material GI sheet, Polythene, Grass/thatch etc) cannot be modelled with the current knowledge of scientific community.
- Estimation of building damage, life loss and economic loss of building is calculated only for direct effects of building damage due to earthquake. Damage estimation for earthquake induced hazards such as landslide, fire or any other reason for death is not taken into consideration.

5. BUILDING TYPOLOGY IN HIMACHAL PRADESH:

There are total 25,75,947 census houses in Himachal Pradesh. 23,15,172 census houses belongs to rural area while just 2,60,785 houses are located in urban area. Distribution of census houses in rural and urban part of all 12 districts of Himachal Pradesh is given in the Fig. 6. Maximum number of urban houses are present in Shimla (24%) and Solan (20%) (Fig.7). Whole area of Kinnaur and Lahul-Spiti district is considered as rural.

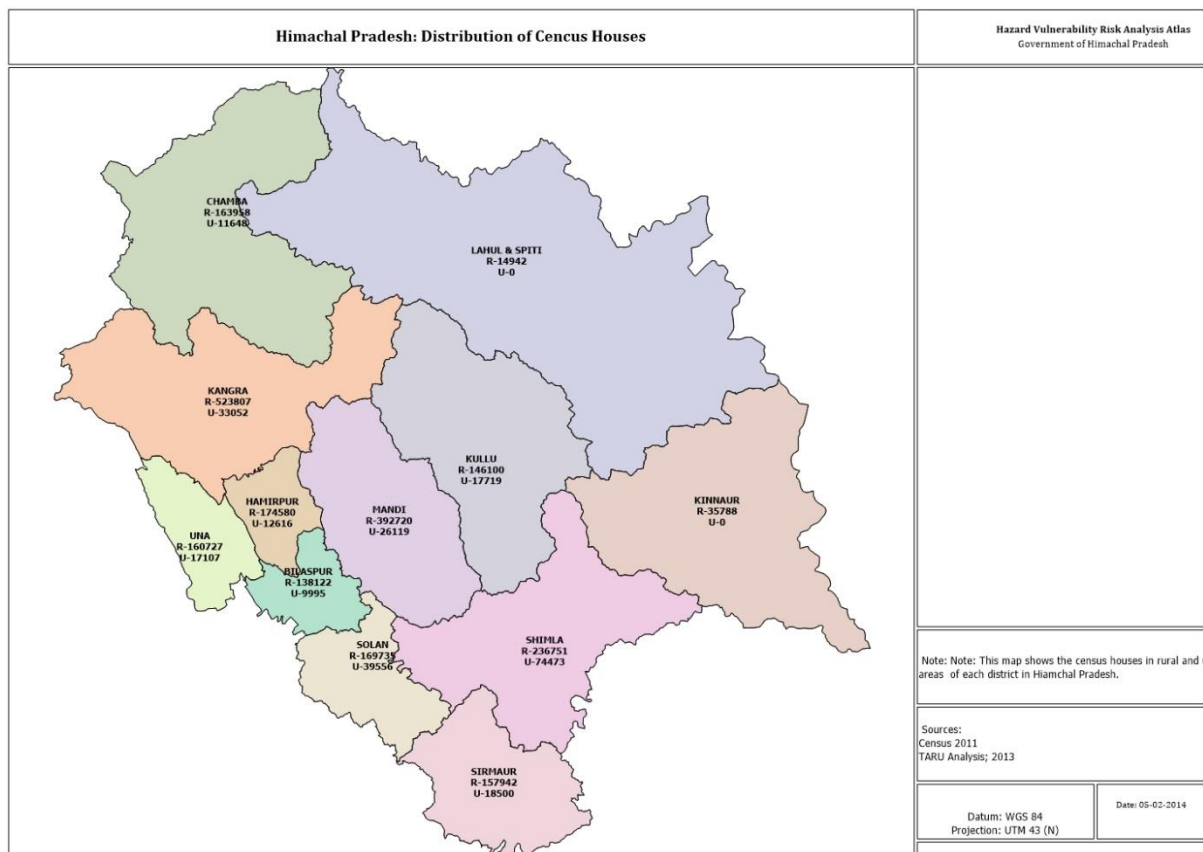

Figure 6: District wise Census House distribution in H.P.(Census of India 2011; TARU Analysis 2013)

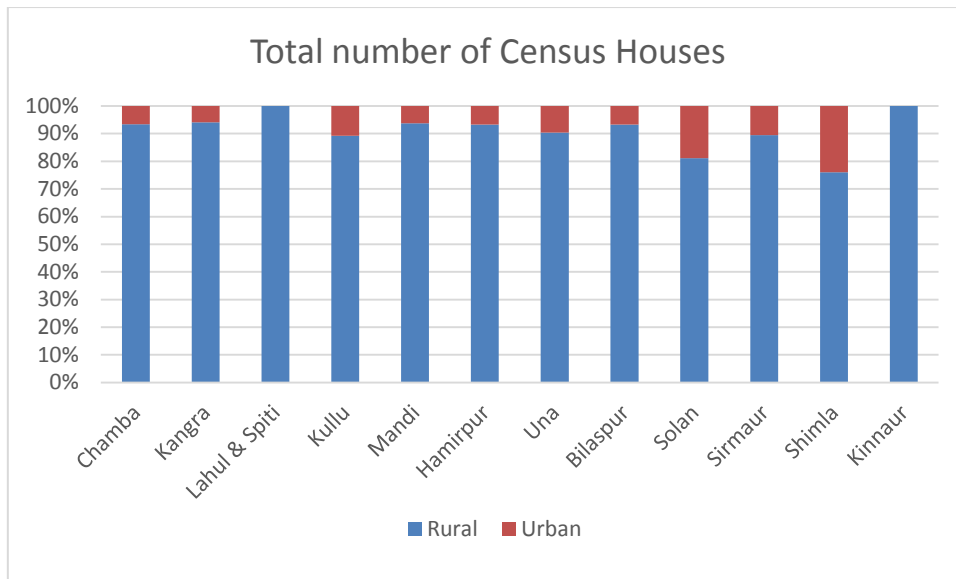

Figure 7: Percentage of Census Houses in Rural and Urban part of Districts in H.P. (Census of India 2011; TARU Analysis 2013)

As per the census 2011, total houses in Himachal Pradesh are over 2.5 million. 55.8 % of buildings are occupied for residential purpose and 7.5 % buildings are used for shop, office etc. 89% of census houses belongs to rural area while only 11% houses exist in urban areas.

5.1 Building Classification by Predominant Roof Material:

Different construction materials or combination of materials have been used in different parts of the state. Census 2011 categorizes buildings on the basis of the different material used for wall, roof and floor. Most of the population belongs to rural area but rural houses lack of seismic safety measures due to poor construction practices. Rural and urban areas have different construction techniques and materials used. Buildings found in different regions (plain or high altitude area) display a different typology.

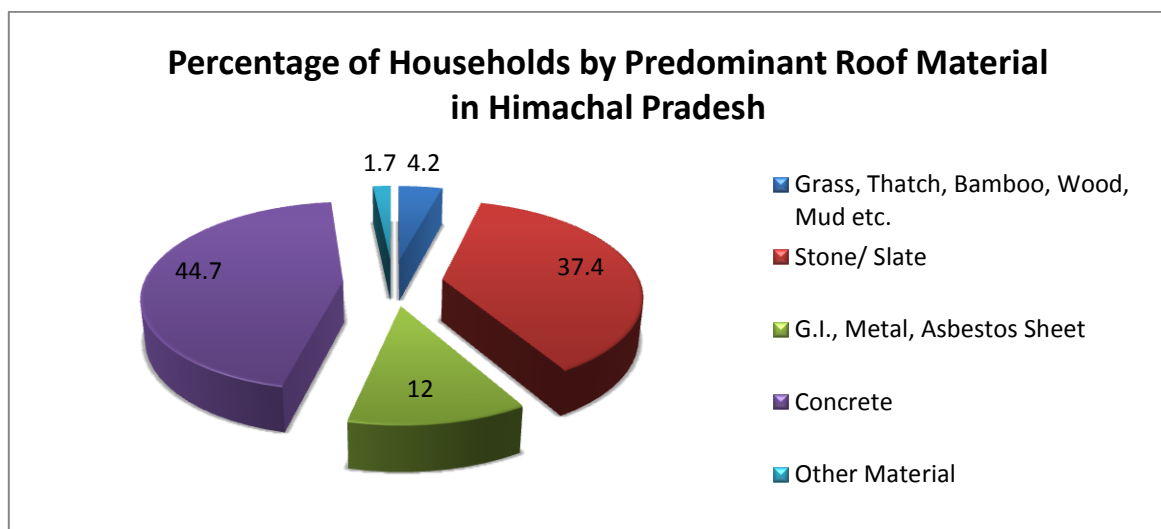

Figure 8: Households Distribution in Himachal Pradesh by Predominant Roof Material (Census of India 2011; TARU Analysis 2013)

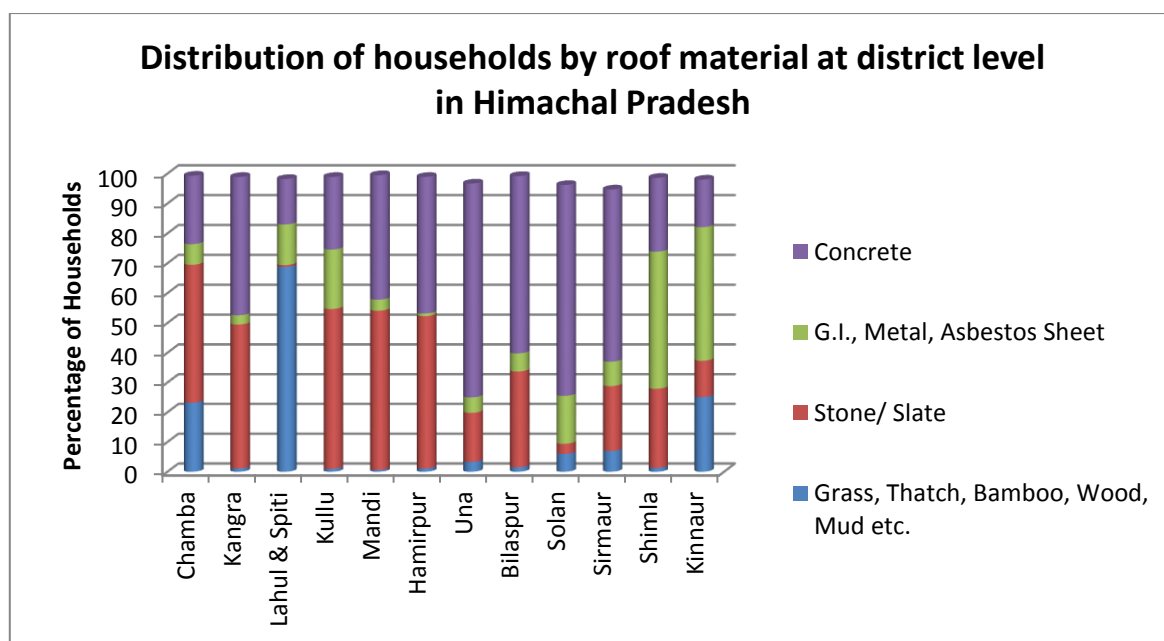

Figure 9: Distribution of Households by roof material at district level in Himachal Pradesh (Census of India 2011; TARU Analysis 2013)

Concrete is used as the predominant material of the roof in urban households followed by stone/ slates and G.I., metal, asbestos sheet (Fig.8). In Lahul & Spiti, more than 65% of households use grass, thatch, wood, mud etc. as a roofing material (Table 3). Maximum concrete roofs (44.7 % concrete roofs in the state) were found in Una, Bilaspur, Solan and Sirmaur district. Shimla and Kinnaur have mostly metal and asbestos sheet for the roof while in other districts, stone/ slates are used as roofing material.

Table 3: Distribution Of Households (%) In Districts Of Himachal Pradesh By Predominant Roof Material

Districts in Himachal Pradesh	Distribution of Households by Predominant Roof Material			
	Grass, Thatch, Bamboo, wood, mud etc.	Stone / Slate	G.I., Metal, Asbestos sheet	Concrete
Chamba	23.2	46.3	6.9	22.9
Kangra	1.1	48.4	3.1	46.3
Lahul & Spiti	68.8	0.6	13.6	15.2
Kullu	1	53.7	19.9	24.3
Mandi	0.6	53.5	3.7	41.7
Hamirpur	1.1	51.2	0.9	45.7
Una	3.3	16.5	5.2	71.7
Bilaspur	1.5	32.2	6.1	59.4
Solan	6	3.4	16.1	70.7
Sirmaur	7	21.8	8.2	57.7
Shimla	1.3	26.6	46	24.7
Kinnaur	25.1	12.2	44.8	15.9

Source: Census of India 2011; TARU Analysis 2013

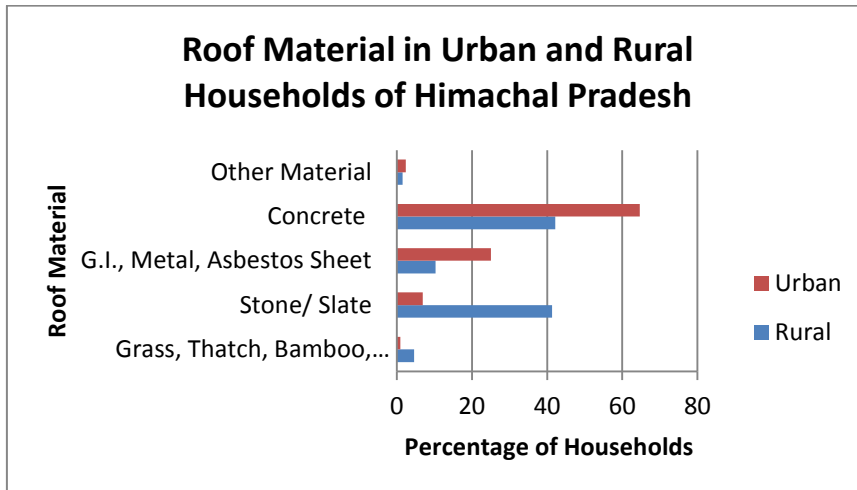

Figure 10: Distribution of Households by roof material in Urban and Rural Himachal Pradesh (Census of India 2011; TARU Analysis 2013)

5.2 Building Classification by Predominant Wall Material:

Burnt brick and stone are the most common wall material in households of Himachal Pradesh followed by mud, unburnt brick and wood. In urban households, burnt brick is the most common material for walls while rural households also use mud and stone along with burnt brick for the construction of walls (Fig. 11). Stone and wood are used as a composite material for walls mostly in Kullu, Shimla and Kinnaur (Fig. 12). Walls made of stone and mud are mostly seen in Lahol & Spiti district. Burnt brick and mud are very common as wall material in Hamirpur and Kangra. Table 4 describes the percentage of households in each district by predominant material of wall.

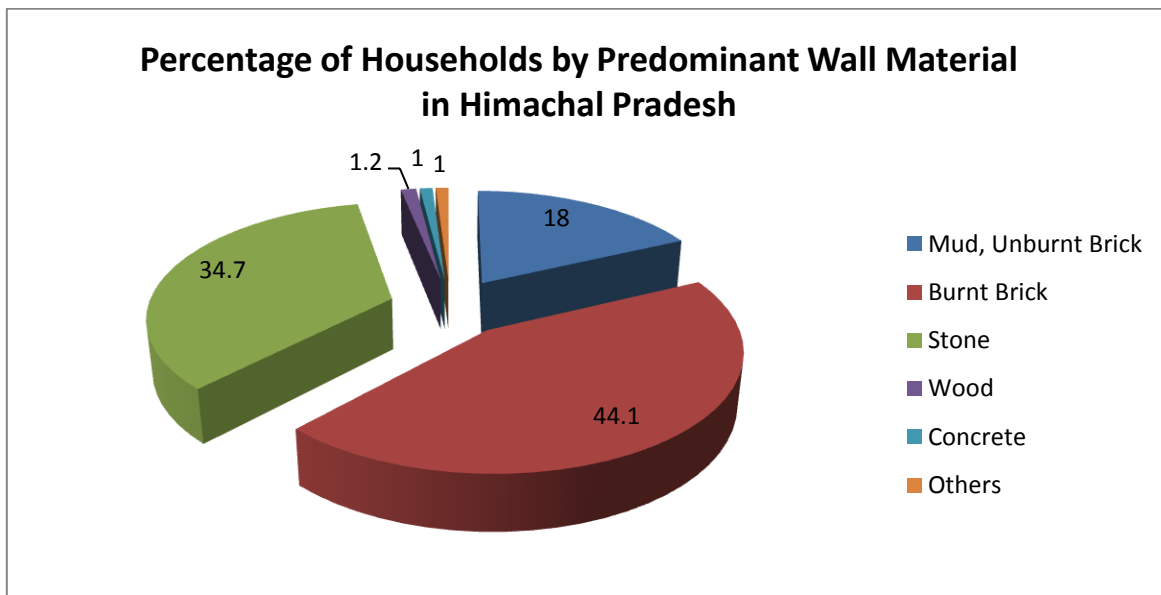

Figure 11: Distribution of Houses by predominant wall material in Himachal Pradesh (Census of India 2011; TARU Analysis 2013)

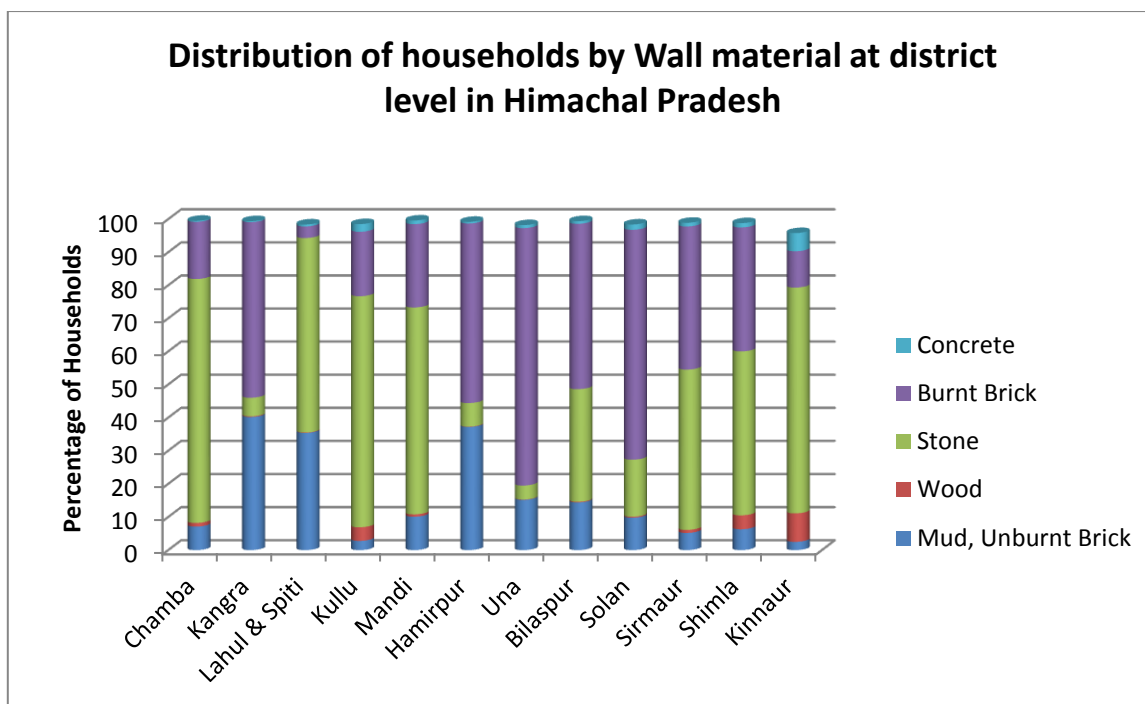

Figure 12: Distribution of Households by roof material at district level in Himachal Pradesh (Census of India 2011; TARU Analysis 2013)

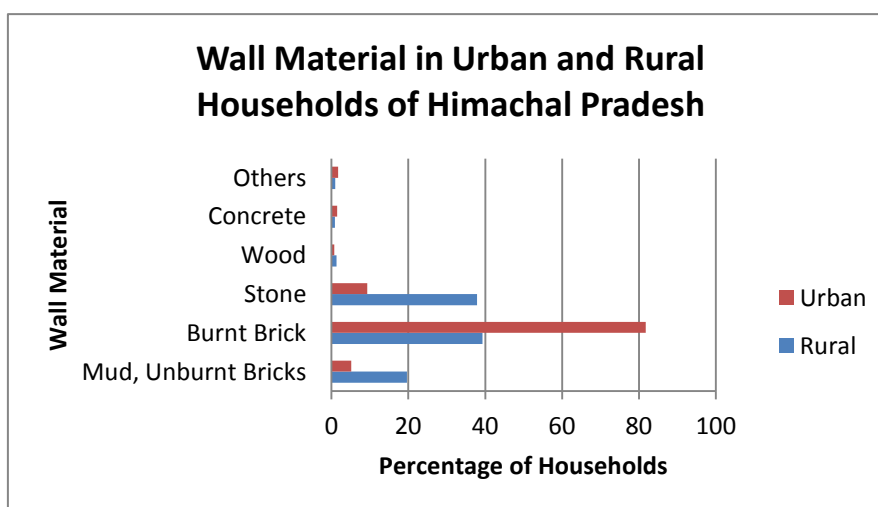

Figure 13: Distribution of Houses by wall material in Urban and Rural parts of Himachal Pradesh (Census of India 2011; TARU Analysis 2013)

Table 4: Distribution Of Households In Districts Of Himachal Pradesh By Predominant Wall Material

Districts in Himachal Pradesh	Distribution of Households by Predominant Wall Material				
	Mud, unburnt Brick	Wood	Stone	Burnt Brick	Concrete
Chamba	7.1	1.1	73.7	17.3	0.3
Kangra	40.2	0.2	5.6	53.1	0.3
Lahul & Spiti	35.4	0.1	58.8	3.5	0.6
Kullu	2.8	4.1	69.8	19.5	2.3

Table 4: Distribution Of Households In Districts Of Himachal Pradesh By Predominant Wall Material

Districts in Himachal Pradesh	Distribution of Households by Predominant Wall Material				
	Mud, unburnt Brick	Wood	Stone	Burnt Brick	Concrete
Mandi	10.1	0.7	62.5	25.2	1.1
Hamirpur	37.2	0.1	7.1	54.3	0.5
Una	15.2	0.1	4.2	77.8	0.9
Bilaspur	14.4	0.2	34	50	0.8
Solan	9.8	0.3	17.2	69.5	1.6
Sirmaur	5.2	0.9	48.4	43.3	1.1
Shimla	6.3	4.2	49.5	37.5	1.3
Kinnaur	2.5	8.6	68.2	11	5.5

Source: Census of India 2011; TARU Analysis 2013

5.3 Building Typology by combination of roof and wall material:

Table 5 represents the predominant building typologies available in different districts of Himachal Pradesh as per the combination of roof and wall material. It was found that building typology vary within a district and also in whole state with the variation of altitude. Houses made of concrete roof and burnt brick wall are found in large proportions in low altitude areas of Kangra, Mandi, Hamirpur, Una, Solan, Sirmaur and Shimla. In high altitude areas of Mandi, Kangra and Shimla such as Karsog, Chinchyot, Dharmsala, Rohru etc., houses made of stone/slate roofing and stone or wood as wall material create a large stock of buildings.

In upper part of Himachal Pradesh such as Chamba, Dharmsala, Kinnaur, Lahul & Spiti, Kullu and some parts in Mandi (Seraj, Chichyot and Karsog), local construction material were used for building construction. Higher transportation cost of modern construction materials (cement, sand and brick) and harsh weather force people in these areas to use stone/slate, mud and grass/thatch/wood as predominant building material. Some old traditional construction type like Dhajji Dewari, Kath Kunni architecture and Thathara houses are still found in rural areas which performed better in previous earthquake events.

All type of predominant building typologies of Himachal Pradesh can be divided in five type of construction. These are RC Frame structures, Brick Masonry, Stone Masonry, Mud Houses and Hybrid constructions. Brick masonry and stone masonry constructions are practiced in more than half of the state. Construction of RC frame structures gained momentum in recent years mostly in Hamirpur, Kangra, Bilaspur, Solan and Shimla. Mud houses are mostly found in rural areas. Hybrid construction are both present in rural and urban areas but mostly in high altitude areas.

Table 5: Predominant building typology in districts of H.P.

District	Predominant Building Typology
Chamba	Stone/ Slate roof and wall made of stone packed with mortar
	Stone/ Slate roof and wall made of stone packed without mortar
	Concrete roof and wall made of burnt brick
	Grass/ thatch roof and wall made of stone packed with mortar

Kangra	Concrete roof and wall made of burnt brick
	Stone/ Slate roof and wall made of mud/ unburnt brick
Lahul & Spiti	Grass/ thatch roof and wall made of mud/ unburnt brick
	Grass/ thatch roof and wall made of stone packed without mortar
	Grass/ thatch roof and wall made of stone packed with mortar
Kullu	Stone/ Slate roof and wall made of stone packed with mortar
	Stone/ Slate roof and wall made of stone packed without mortar
	Concrete roof and wall made of burnt brick
	G.I./metal/asbestos sheet roof & wall made of stone packed with mortar
Mandi	Stone/ Slate roof and wall made of mud/ unburnt brick
	Stone/ Slate roof and wall made of stone packed with mortar
	Stone/ Slate roof and wall made of stone packed without mortar
	Concrete roof and wall made of burnt brick
	Concrete roof and wall made of stone packed with mortar
Hamirpur	Stone/ Slate roof and wall made of mud/ unburnt brick
	Concrete roof and wall made of burnt brick
Una	Concrete roof and wall made of burnt brick
Bilaspur	Concrete roof and wall made of burnt brick
Solan	Concrete roof and wall made of burnt brick
Sirmaur	Concrete roof and wall made of burnt brick
	Concrete roof and wall made of stone packed with mortar
	Stone/ Slate roof and wall made of stone packed with mortar
Shimla	Concrete roof and wall made of burnt brick
	G.I./metal/asbestos sheet roof & wall made of stone packed with mortar
	G.I./metal/asbestos sheet roof & wall made of burnt brick
	Stone/ Slate roof and wall made of stone packed with mortar
Kinnaur	G.I./metal/asbestos sheet roof & wall made of stone packed with mortar
	Grass/ Thatch roof and wall made of stone packed with mortar
<i>Source: Census of India 2011; TARU Analysis 2013</i>	

Figure 14 to 18 represent the distribution of major building typology of Himachal Pradesh in roof-wall material combination. Figure 14 shows the four maps which represent distribution of census houses made of burnt brick wall and four predominant roof material i.e. burnt brick, stone/slate, GI/Metal/Asbestos and concrete. Total number of census houses made of burnt brick wall are also shown on right top corner of the map. Table 6 shows the percentage of predominant building typology with respect to roof wall combination. Census houses made of burnt brick wall and concrete roof share 36 % of total houses (Table 6). From figure 14 shows that this particular building type is mainly concentrated in areas of Kangra, Una, Hamirpur, Solan, Sirmaur, Bilaspur and Mandi.

Stone masonry houses (with mortar) with stone/slate roof represent 13% of total houses and they are mostly found in Chamba, Kullu and Shimla (Figure 15 & Table 6). RC frame buildings are mostly concentrated in Shimla, Kullu, Mandi, Hamirpur, Bilaspur and Solan (Figure 18). After brick and stone masonry, mud houses are third largest category (18%) of building type. Mud/Unburnt brick houses are mostly built with stone/ slate or Grass/Thatch/ Bamboo roofing. Mud houses with grass/thatch roofing are mostly located in chamba, Spiti, Kangra and Sirmaur (Figure 17) while mud houses with stone/ slate roofing are mostly concentrated in Chamba, Kangra, Kullu and Mandi.

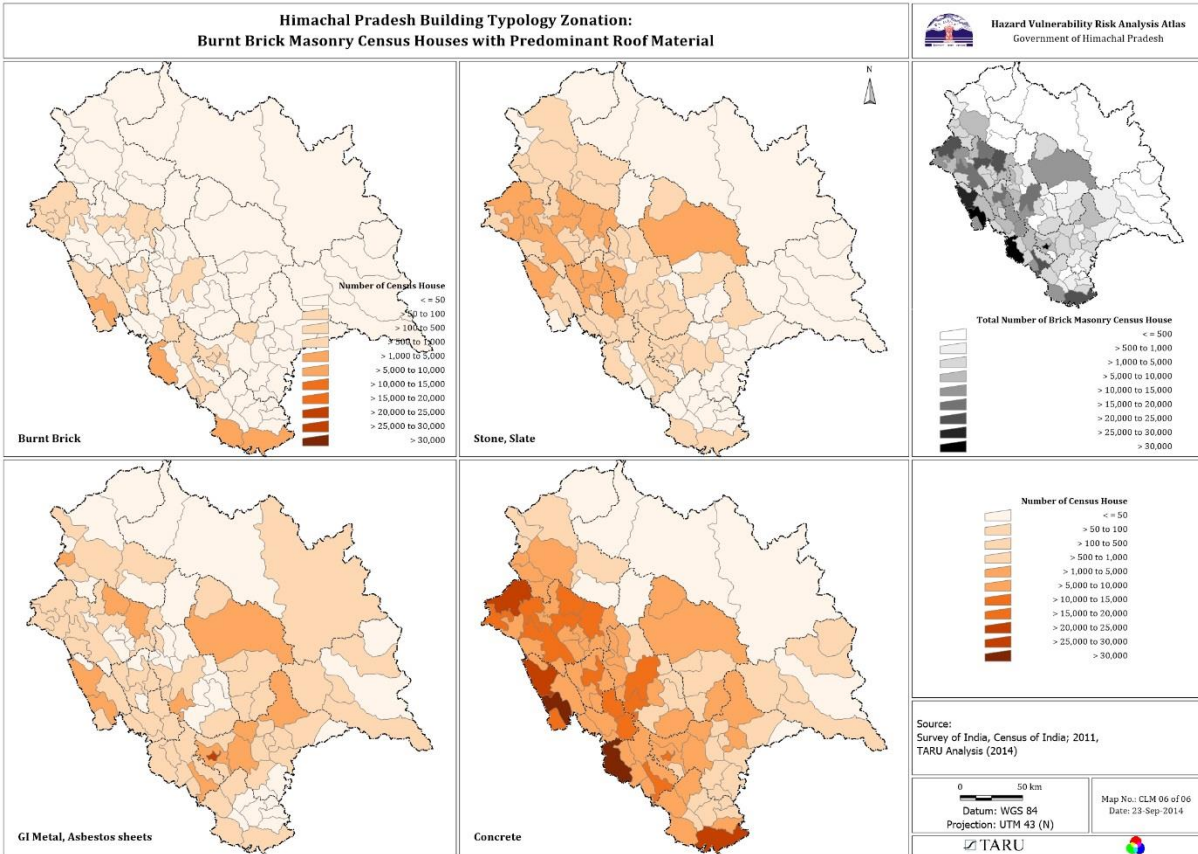

Figure 14: Brick Masonry Census Houses with Predominant Roof Material

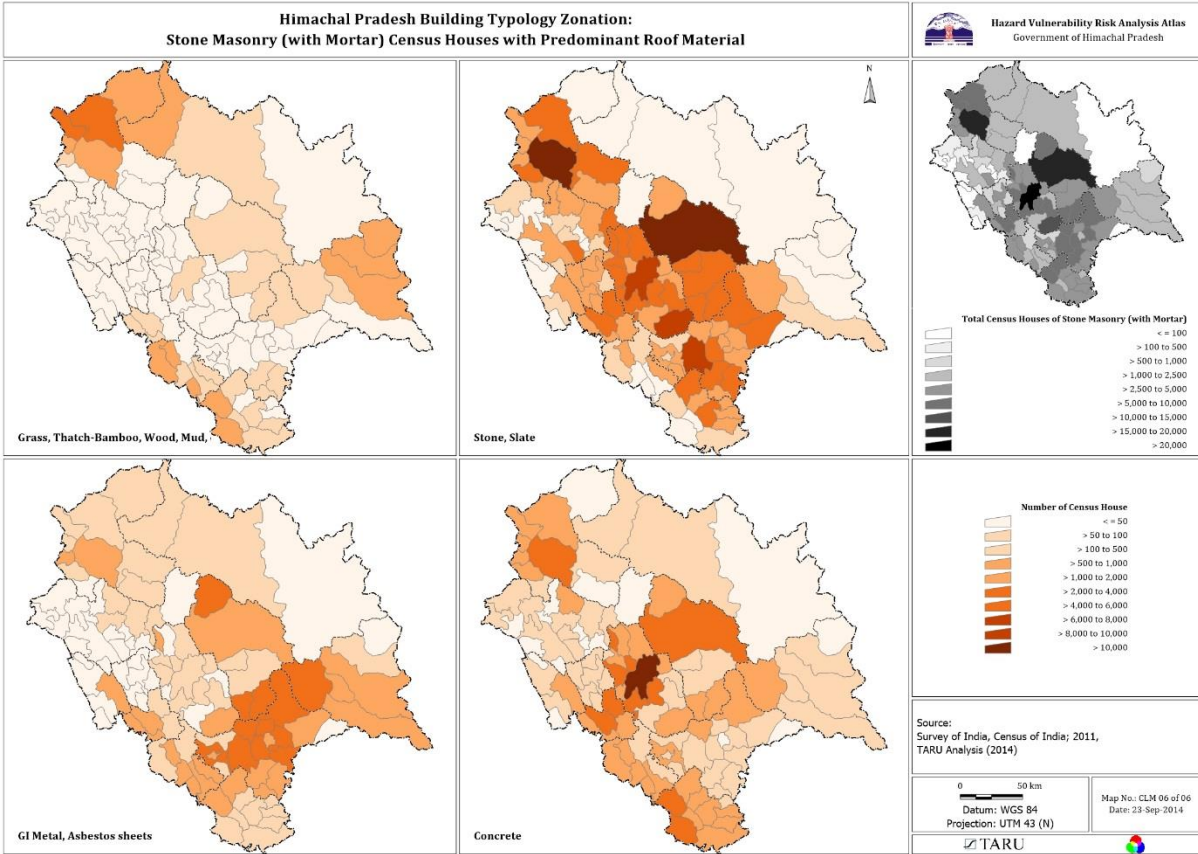

Figure 15: Stone Masonry (with mortar) Census Houses with Predominant Roof Material

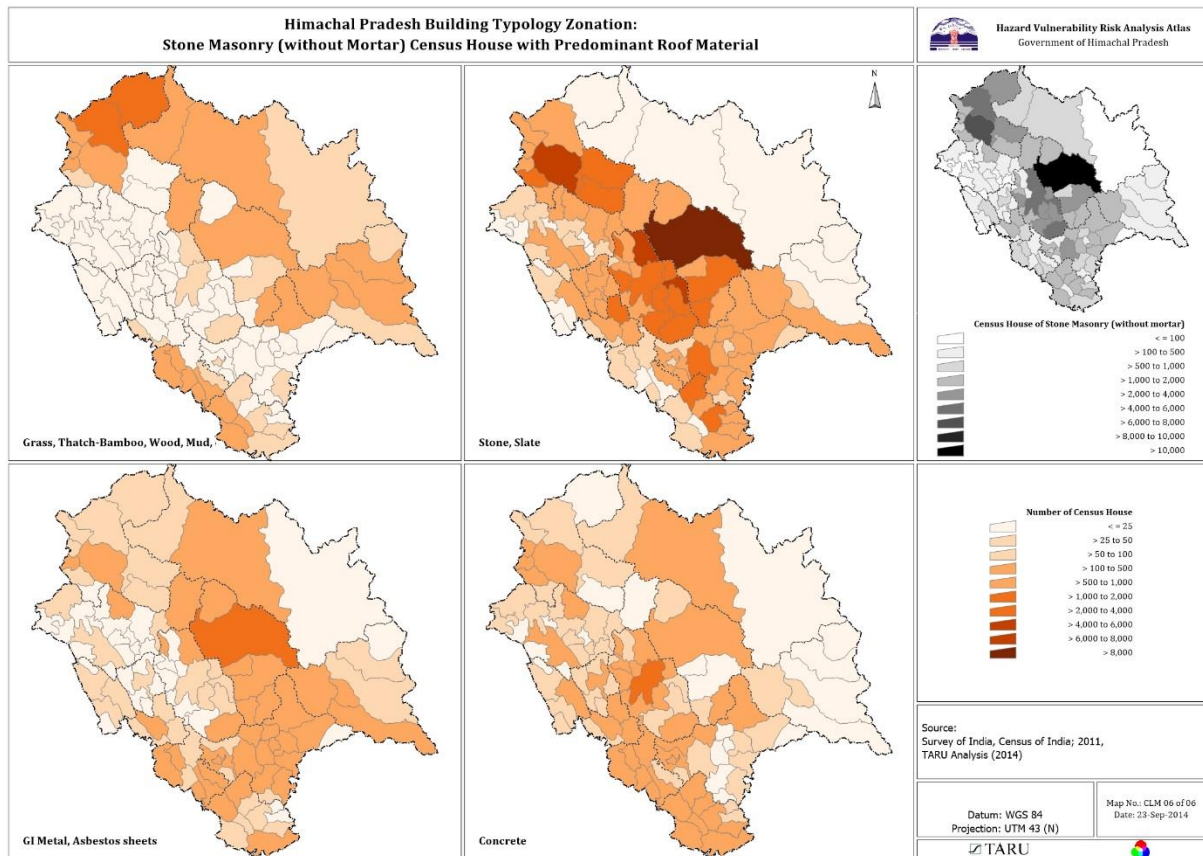

Figure 16: Stone Masonry (without mortar) census houses with Predominant Roof Material

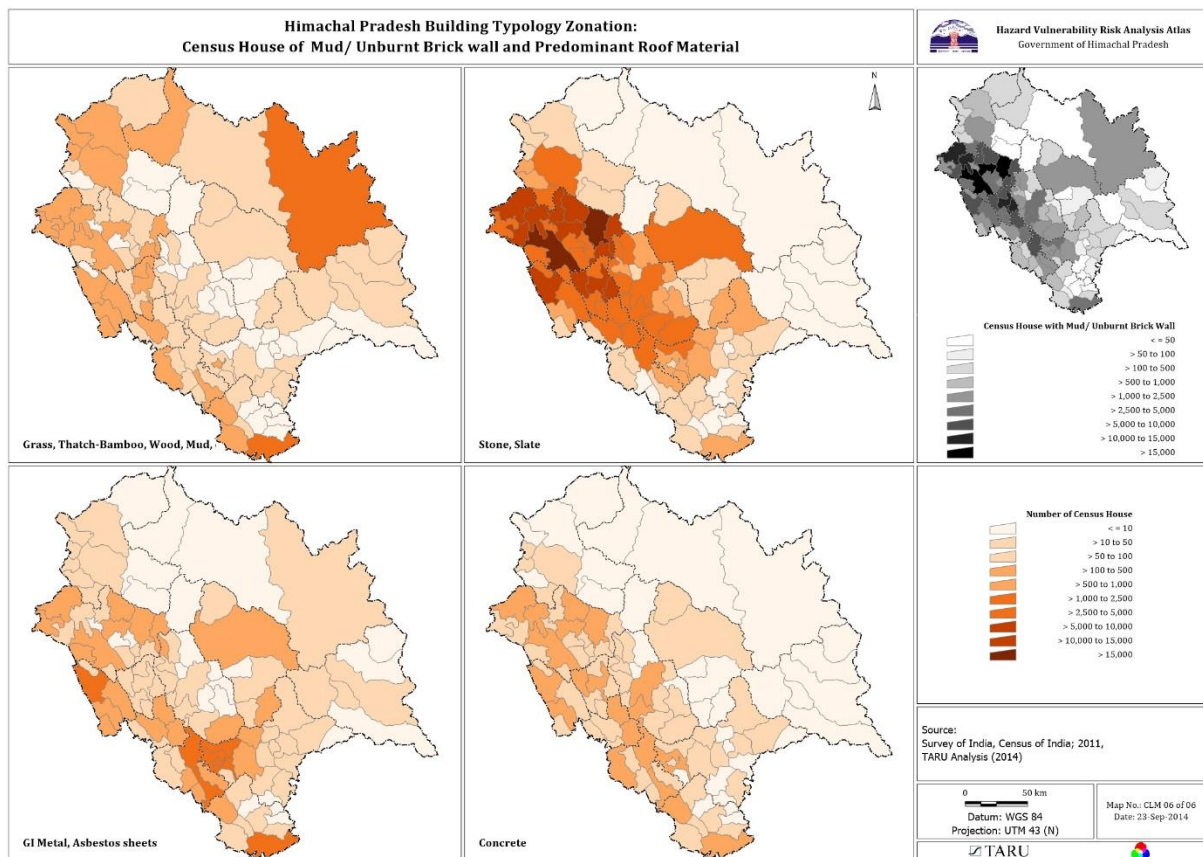

Figure 17: Census Houses made of Mud/Unburnt Brick Wall and Predominant Roof Material

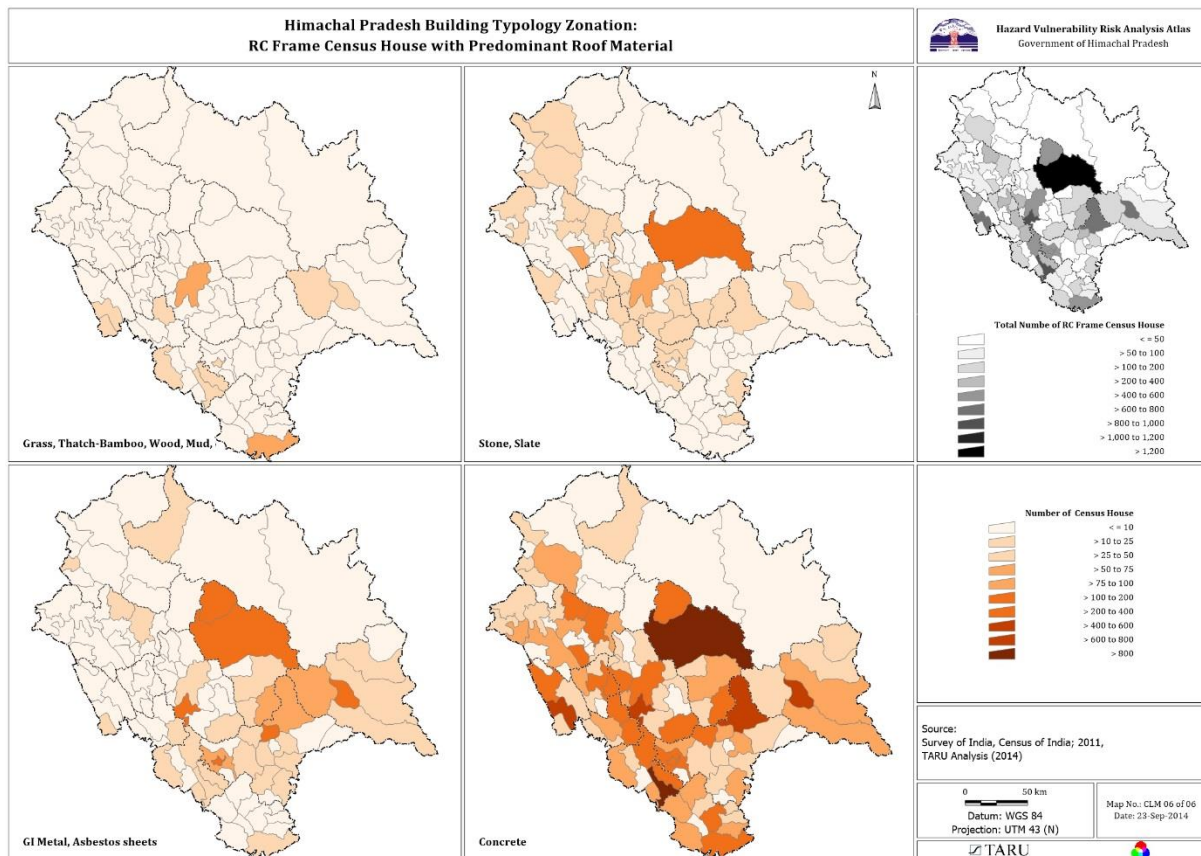

Figure 18: RC Frame Census Houses with Predominant Roof Material

Table 6: Percentage Of Predominant Building Typology In Himachal Pradesh									
Material of wall	Material of Roof								
	Grass/ Thatch/ Bamboo/ Wood/ Mud etc.	Plastic/ Polyth- ene	Handma- de Tiles	Machine made Tiles	Burnt Brick	Stone/ Slate	G.I./ Metal/ Asbestos sheets	Concrete	Any other
All material	4.17	0.35	0.20	0.17	0.86	37.38	12.01	44.76	0.11
Grass/thatch/ bamboo etc.	0.24	0.07	0.00	0.00	0.00	0.06	0.05	0.00	0.00
Plastic/ Polythene	0.01	0.13	0.00	0.00	0.00	0.02	0.02	0.00	0.00
Mud/unburnt brick	0.84	0.03	0.05	0.02	0.04	15.09	1.50	0.40	0.02
Wood	0.11	0.05	0.00	0.01	0.01	0.61	0.43	0.00	0.00
Stone not packed with mortar	0.91	0.02	0.02	0.01	0.04	5.51	1.19	1.07	0.01
Stone packed with mortar	1.79	0.02	0.05	0.02	0.09	12.73	4.75	6.43	0.02
G.I./metal/ash bestos sheets	0.01	0.00	0.00	0.00	0.00	0.03	0.20	0.03	0.00
Burnt brick	0.22	0.02	0.07	0.10	0.67	3.23	3.71	36.06	0.05
Concrete	0.03	0.00	0.00	0.00	0.01	0.08	0.14	0.72	0.00
Any other	0.01	0.00	0.00	0.00	0.00	0.02	0.02	0.04	0.00

Source: Census of India 2011; TARU Analysis 2013

5.4 Traditional Building Typologies of Himachal Pradesh:

In Himachal Pradesh, some very old construction practice has been observed in Dharmsala, Bharmour (Chamba), Lahul & Spiti, Kullu and Shimla which have performed better than other existing buildings in previous earthquakes. These building typologies are Dhajji Dewari, Kath Khunni and Thathara (Table 7).

Table 7: Traditional Construction Practice In Different Districts Of Himachal Pradesh	
Name of the Building Typology	Districts where it is found
Dhajji Dewari	Shimla, Kangra
Kath Kunni	Kinnaur, Chamba, Lahul and Spiti, Kullu
Thathara	Chamba

Source: TARU Analysis 2013

5.4.1 Dhajji Dewari:

Dhajji Dewari is a traditional construction type mainly found in Shimla and Kangra district of Himachal Pradesh. In Indian standard code, it is termed as brick naged timber frame construction. In this construction technique, timber frame is used as bracing and space between frames is filled with brick or stone traditionally laid into mud mortar (Fig. 19). Completed walls are plastered with mud mortar.



Figure 19: Dhajji Dewari Type House (Shimla, 13th November 2013)

Seismic Behaviour of Dhajji Dewari: At the time of earthquake shaking, masonry infill panels quickly crack in plane and thus absorb the energy through friction against the timber framing and between the cracks in the fill material. Timber frame and closely spaced bracing prevents propagation of large cracks through the infill walls due to their elastic behaviour. Timber bracing provide the robust boundary conditions for the infill material to arch against and thus resist the out of plane inertial loads.

If these houses are constructed carefully with good quality of materials, it can perform well in earthquakes. Dhajji Dewari houses built in Himalayan region performed well in previous earthquakes.

5.4.2 Thatara House:

This building type is mostly found in Chamba district of Himachal Pradesh. Locally term “Thathara” is used for wooden planks and they are use as vertical load carrying members (Fig. 20). Thathara houses are mostly built in cold regions which witness heavy snowfall in winter season (October to March). These houses have sloping roofs with adequate projection to take care of snow deposition on roof. Mud and wood interiors keep the house warm.



Figure 20: Thathara House (Bharmour, Dist. Chamba, 20thOctober 2013)

Seismic Behaviour of Thatara Houses: The structural system of this building typology consist of ‘Tholas’ and wooden beam. Tholas are the vertical load carrying members which are made of stone and Thatharas (plank, log or piece of wood). Generally there is no mortar used in Tholas. Tholas are provided at the corner or ridges of the building and support the horizontal beams which in turn support the inclined rafters and purlins. The structure contains a complete load path for seismic force effects from any horizontal direction that serves to transfer inertial forces from the building to the foundation.

5.4.3 Kath Khuni Architecture:

Kath Khuni is very old traditional construction style which was evolved more than 100 years ago. Generally long thick log and stone are used as alternate layer of wall material for this kind of structure (Fig. 21). Lot of features of Kath Khuni architecture provide the basis for modern earthquake resistant design. Like alternate layers of wooden log

around the wall work as horizontal bands required for masonry construction. Roofs are constructed with slates.



Figure 21: Kath Khuni Architecture (Village: Dharmaling, Kinnaur, 29th September 2013)

Seismic Behaviour of Kath Khuni Structures: The building configuration provides adequate safety against lateral shear, but there is no apparent safety measure against overturning. The primary structural system mainly consists of wooden elements. If designed and used properly, wood assemblies offer a high strength-to-weight ratio compared with other modern work materials. This results in low inertia forces during an earthquake.

6. BUILDING VULNERABILITY IN HIMACHAL PRADESH-KEY ASPECTS:

Vulnerability atlas of India (2nd edition, BMTPC 2006) describes the buildings vulnerability for earthquake, wind and flood. As per this vulnerability atlas, 44.2% of area of the state is situated in seismic zone V while 55.8% area lies in seismic zone IV. This atlas classify buildings with respect to wall and roof material. Wall material has four major category i.e. A, B, C and X. Further wall category A and C have been divided into sub categories such as A1, A2 and C1, C2 (Table 8).

Roof type of houses are defined in three categories i.e. R1, R2 and R3 where R1 and R2 are light and heavy sloping roofs while R3 represents the flat roofs. A detailed description of these classification is given in table 8. Houses made of category A wall material (mud and unburnt brick wall, stone wall) and category B and are highly vulnerable in both seismic zone V and IV. Buildings having wall material of category C (concrete and wood wall) and X (other wall materials) are medium or low vulnerable.

Buildings constructed with light weight sloping roof have medium level of risk while buildings with heavy weight sloping roof have high level of risk in seismic zone V area. For flat roof buildings, damage risk depend on the wall supporting it.

91.2 % area of the state have the maximum wind velocity as 44 & 39 m/s and 8.7% area have the max. wind velocity as 47 m/s. Buildings with light weigh roof material have high level risk of damage for high wind speed .A building can be vulnerable due to multiple reasons such as due to construction material issues, level of workmanship, architectural aspects of the building, structural integrity or bad construction practices with violation of IS codes.

Table 8: Distribution Of Houses By Predominant Materials Of Roof And Wall And Level Of Damage Risk In Himachal Pradesh

Wall Roof		Census House	No. of Houses	%	Level of Risk Under					
					EQ Zone		Wind Velocity m/s			
					V	IV	55 &50	47	44&39	33
					Area in %		Area in %			
44.2	55.8	0.1	8.7	91.2						
Wall										
A1- Mud Unbrunt Brick Wall	Rural	640,847	26.6							
	Urban	20,946	0.9							
	Total	661,793	27.5	VH	H	VH	H	M		
A2 - Stone Wall	Rural	982,235	40.8							
	Urban	30,368	1.3							
	Total	1,012,603	42.1	VH	H	H	M	L		
Total- Category-A		1,674,396	69.5							
B- Burnt Brick Walls	Rural	455,886	18.9							
	Urban	168,730	7							
	Total	624,616	25.9	H	M	H	M	L		
Total- Category-B		624,616	25.9							
C-1 Concrete Wall	Rural	10,230	0.4							
	Urban	8,193	0.3							
	Total	18,423	0.7	M	L	L	VL	VL		
C-2 Wood Wall	Rural	43,416	1.8							
	Urban	5,218	0.2							
	Total	48,634	2	M	L	VH	H	M		
Total-Category-C		67,057	2.8							
X-Other Materials	Rural	35,725	1.5							
	Urban	7,128	0.3							
	Total	42,853	1.8	M	VL	VH	H	M		
Total-Category-X		42,853	1.8							
Total Buildings		2,408,922								
Roof										
R1- Light Weight Sloping Roof	Rural	534,297	22.2							
	Urban	64,512	2.7							
	Total	598,809	24.9	M	M	VH	VH	H		
R2-Heavy Weight	Rural	1,076,451	44.7							

Sloping Roof	Urban	22,355	0.9						
	Total	1,098,806	45.6	H	M	H	M	L	
R3- Flat Roof	Rural	557,591	23.1						
	Urban	153,716	6.4						
	Total	711,307	29.5	Damage Risk as per that for the wall supporting it					

Source: Vulnerability Atlas of India, 2nd edition, BMTPC 2006

Housing Category- Wall Types	Housing Category-Roof Type
Category-A: Buildings in field stone, rural structures, unburnt brick houses, clay houses	Category-R1: Light Weight (Grass, Thatch, Bamboo, Wood, Mud, Plastic, Polythene, GI Metal, Asbestos sheets, Other materials)
Category-B: Ordinary Brick Building, Building of the large block and prefabricated type, half-timbered structures, building in natural hew stone	Category-R2: Heavy Weight (Tiles, Slate)
Category-C: Reinforced Building, Well-built wooden structures	Category-R3: Flat Roof (brick, Stone, Concrete)
Category-X: Other materials not covered in A,B,C. These are generally light.	

EQ Zone V	Very High Damage Risk Zone (MSK>IX)
EQ Zone IV	High Damage Risk Zone (MSK VIII)
EQ Zone III	Moderate Damage Risk Zone (MSK VII)
EQ Zone II	Low Damage Risk Zone (MSK <VI)
Level of Risk	VH= Very High, H= High, M= Moderate, L= Low, VL= Very Low

Vulnerability issues in the existing buildings of Himachal Pradesh have been addressed below under five major category:

6.1 Non availability and high cost of construction material:

During reconnaissance in H.P. for identifying available building typology, it was observed that use of construction material varies with change in altitude. In low altitude areas of H.P. close to the Punjab border, modern construction materials such as burnt brick, cement, and concrete are used for constructing most of the buildings. High altitude rural areas have been using mostly stone, wood and mud as construction material due to mainly two reasons i.e. high transportation cost of material and advantage of wood, stone and mud in very cold weather as thermal insulator. Unawareness of using modern construction material might be the other reason for less/ no use of these materials in remote areas. Following facts were obtained from data collected during economic loss estimation survey of buildings along with RVS:

- Data collected about the cost of construction materials and labours during RVS indicate a significant difference in the cost of construction of houses in low and high altitude areas. Cost difference of per bag cement between Una (altitude 350 m from m.s.l.) and Kinnaur (altitude 2400 m from m.s.l.) varies from INR 60 to 80. A bag of cement cost INR 320-340 in Una while it goes as high as INR 400 in Kinnaur. Low skilled masons and labours are available in rural areas which

affects the construction quality of building in terms of both technical competencies and workmanship.

- Data collected of construction materials for economic loss estimation of buildings reveals that wood is mostly used in Kinnaur, Lahul-Spiti and Chamba districts. Burnt brick was rarely used in these districts, primarily due to non-availability of burnt bricks locally, high transportation cost and very cold weather. Cost of per burnt brick varies from INR 6 (in Una and Kangra) to INR 10 in Kinnaur and Lahul-Spiti region. As burnt bricks are exported from other districts, high transportation cost make it less used material in comparison to locally available wood and stone. This forces residents of these areas to use the locally made concrete block instead of purchasing costly burnt brick from outside. Although strength of these bricks is very doubtful as people make these bricks without or very little knowledge of making bricks.

6.2 Non code compliance:

Even though lot of buildings in Himachal Pradesh are brick masonry and RC frame but most of them have been built without taking care of codal provisions for seismic safety. Mostly residential buildings are non- engineered construction. Very few masonry buildings have been provided with horizontal band (plinth band, sill band, lintel band and roof band) and vertical reinforcement near the door and jamb openings which are the basic requirement of earthquake safe masonry constructions.

Fig. 22 is the stone masonry construction of PWD office building in Hamirpur district. Ground floor does not have any horizontal seismic band while first floor is provided with lintel band only. There is no sill band and roof band provided. It is possible that both floors might have been constructed in different time duration. As IS 13828:1993 “Improving Earthquake Resistance of Low strength masonry buildings-Guidelines” was introduced in 1993, it might be possible that ground floor was constructed before 1993 and hence there was no horizontal bands given in the building. Fig. 23 is Anganwadi Kendra in Bhoranj, Hamirpur. This brick masonry building was not provided with any seismic features (no seismic horizontal band and no vertical reinforcement near door and jamb openings). It makes building very vulnerable during earthquake and this building can collapse in strong earthquake.



Figure 22: PWD office building in Hamirpur (Hamirpur, 23rd August 2013)



Figure 23: Brick Masonry construction of Anganwadi (Bhoranj, Hamirpur, September 2013)

6.3 Level of workmanship:

Poor workmanship in construction can lead to the serious problem into buildings. If a building is made without engineered supervision, it has chance to be more vulnerable to damage during disaster. Most of the problem occurs in providing the shuttering for concreting. RC frame should be orthogonal to provide proper frame behavior for load transfer i.e. beam and column should be perpendicular to each other to avoid torsional forces. Non orthogonal frame (beam and column) will not be able to transfer load properly. Honeycombing of concreting is also a result of poor workmanship in which concrete fails to fill the voids between the aggregates and it occurs due to inappropriate

vibration during concreting. Deeper areas of honeycombing can lead to local reduction in concrete cover of reinforcement and this may cause durability problems in future.

6.4 Poor Construction Practices:

Numerous poor/bad construction practices are followed in the state including horizontal and vertical irregularities, re-entrant corners, and heavy overhangs etc. which make the buildings more prone to risk during disasters. Following observations were made during the rapid visual screening of buildings across the state:

6.4.1 Hybrid Construction:

Hybrid construction is observed in many places. If two floors have been constructed using different construction practices (Example: masonry and RC Frame), it is termed as hybrid construction (Fig. 24). Hybrid construction can prove to be disastrous for the building at the time of earthquake. Load path mechanisms vary in hybrid construction. Example: If the first floor is brick masonry construction and the second floor is RC frame construction, then load transfer will occur from the columns of the second floor RC frame structure to the corner of the load-bearing walls of the ground floor structure. Load concentration at the corner of the wall can lead to severe cracks in the building.



Figure 24: Hybrid Construction (RC Frame and Brick Masonry) in Kangra



Figure 25: Hybrid Construction (Stone masonry and brick masonry)

6.4.2 Pounding due to close proximity of two buildings:

It was found common that two parts were attached to each other even if they were constructed at different year and using different construction type. This type of practice should be avoided as this make more vulnerable to a building. Buildings constructed at different time scale should maintain a gap of minimum 2 inch so that all block behave separately in case of shaking due to earthquake and pounding effect can be avoided.

Pounding is the result of irregular response of adjacent buildings of different heights and of different dynamic characteristics. In situations where two buildings are located too close to each other, they may collide during strong shaking leading to substantial damage. The pounding effect is more pronounced in taller buildings (fig. 26). When building heights do not match, the roof of the shorter building may pound at the mid-height of the columns in the taller building; this can be quite dangerous, and can lead to storey collapse.



Figure 26: Possible location of occurrence of pounding

6.4.3 Roof without waterproof solution:

Water seepage was found in almost all the buildings. Water proofing treatment to roof should always be given as water seepage problem pose a serious threat to the buildings. Reinforcement of slab, beam and column get corroded due to water seepage which reduced the load carrying capacity of the building elements. Excessive corrosion also lead to vertical cracks in the longitudinal steel of the column and horizontal cracks in the beam.



Figure 27: Water seepage problem in the roof and wall (Hamirpur, 16th December 2013)

6.4.4 Beam Column Junction:

A very common problem at the junction of beam column was found in almost everywhere in the state. It was observed that centre line of beam and column were not passing through a same line (Fig. 28). Generally beam is provided offset to one direction of the column. This kind of beam column junction provide the eccentricity and it will create torsional forces. It was find out that masons provide this type of joint just to avoid extra shuttering which will be require to keep the load path for beam column at same line. This is bad construction practice and it should be avoided.



Figure 28: Wrong Practice of Beam Column Junction

6.4.5 Plan Irregularities:

Few buildings were found to have plan irregularity i.e. L shape, U shape etc. Buildings with regular plan (rectangular or circular) perform better during earthquake. If irregular shape like L, H, U or + are designed, construction joints should be provided at the junction of two different wings to avoid re-entrant corners. If a construction joint is not provided, buildings have the tendency to separate out from these corners.

The dimension of the offset and the proportion of the derived wings will determine the vulnerability of a building. Each wing will react to the displacements and the torsional effects produced by ground motions in a different way. Under the action of earthquake forces, each wing will have a different dynamic behaviour because of its particular stiffness and position relative to the direction of horizontal forces. The movement of different parts of the building can be very complicated, producing considerable diaphragm deformation, torsional effects and concentration of stress at the vertices of re-entrant corners. Figure 29 shows the re-entrant corner present in the building.



Figure 29: Re-entrant corner in L shape building (Kangra, 17th December 2013)

6.5 Site Morphology and Local Soil Condition:

Site morphology plays a vital role in defining the vulnerability of buildings. As most of the building site is sloping ground, precautions need to be taken to stabilize the slope before construction of building. Retaining wall must be provided before construction in sloping site. For a stepback building construction, separate columns should be provided for different floors although same foundation can be given. For a building located on sloping site, column with unequal height in the ground storey should be avoided as shorter column being stiffer attract more horizontal forces and are liable to fail in shear.



Figure 30: Construction of building on sloping site

The intensity of ground motion at a particular site predominantly depends on the distance the causative fault and local soil conditions. There exists a strong correlation between Peak Ground Velocity (PGV) and the shear wave velocities of local soils. Site amplification is one of the major factors that increase the intensity of ground motions. Although it is difficult to obtain precise data during a street survey, an expert observer could be able to classify the local soils as stiff or soft. The geotechnical data provided by local authorities is a reliable source for classifying the local soil conditions. The risk of building increases, as the softness of soil increases. If the soil is sandy and is saturated with ground water, there is a possibility of liquefaction during earthquakes as the soil loses its firmness and behaves as a jelly. (Source: RVS Report, EERC, IIT Hyderabad). Figure 30 shows the construction of building on a sloping site and collapse of a under construction building in Shimla. A proper site selection or slope and soil stabilization method could have avoided this failure.

7. RAPID VISUAL SCREENING (RVS)

Rapid Visual Screening (RVS) was conducted on 9099 buildings in the state of Himachal Pradesh and photographic summary of 9622 identical buildings was taken which were having similar structural characteristics. In this study, buildings were classified into five different typologies i.e. Reinforced Concrete Frame Structure, Brick Masonry, Stone Masonry, Rammed Earth buildings and Hybrid & others. The RVS methodology is referred to as a “sidewalk survey” in which an experienced screener visually examines a building to identify features that affect the seismic performance of the building, such as the building type, seismic zone, soil conditions, horizontal and vertical irregularities, apparent quality in masonry and RC structures and short column etc. This walk survey

is carried out based on the checklists provided in a proforma for all five typology of buildings. Other important data regarding the building is also gathered during the screening, including the occupancy of the building and the presence of nonstructural falling hazards. A performance score is calculated for the building based on numerical values on the RVS form corresponding to these features. The performance score is compared to a “cut-off” score to determine whether a building has potential vulnerabilities that should be evaluated further by an experienced engineer. Gaussian distribution is applied for cut off score in this study.

7.1 Design of Integrated RVS Format:

Few RVS format were previously designed by Prof. Arya, IIIT Roorkee and Prof. Ravi Goyal, IIT Bombay. These formats were designed only for one disaster i.e. earthquake. All the available RVS format were critically examined and it was felt that a more robust and detail RVS format is required to assess the present condition of the existing building stock in Himachal Pradesh. As HVRA_HP initiative takes into account the multiple hazard, therefore it was required to consider other hazards also like flood, landslide and fire. Questions related to building distress, corrosion of reinforcement, water seepage problem were also introduced as these problems in the existing format of RVS were overlooked which may cause serious threat to building safety.

Hazard	Geological: Earthquake, Landslide Hydro-meteorological: Riverine Flood, Flash Flood, Cloud Burst, Wind Storm , Avalanche Other Hazard: Lightning, Fire, Forest Fire
Type of Buildings chosen for RVS	Residential, Educational. Institutional, Assembly, Commercial, Emergency, Service, Important Government Office and Cowsheds
Site Characteristics	Site Morphology, Soil type, Soil Nature, Liquefaction Potential of soils, Slope of the ground
Type of Construction	Rammed Earth, Brick Masonry, Stone Masonry, RC Frame, Hybrid structures
Vulnerability Factors	Architectural Features: Shape of the building, Dimension of building and building elements i.e. wall, beam and column
	Material Characteristics: Material of wall, floor and roof, mortar, ratio of mix mortar
	Structural Features: orthogonal frame, presence of secondary beams, presence of horizontal band, ratio of wall length and height to the thickness of the wall
	Workmanship: Quality of concreting, quality of construction
	Building Distress: presence of cracks, cracks width and their shape, different deformation, level of corrosion
Other Information Collected	Building damage loss due to landslide, flood and fire, Reason of fire, Year of the event, height of inundation, duration of water logging, lat/long using GPS and 3 photographs of each building
<i>Source: TARU Analysis 2013</i>	

For Flood, information related to structural damage loss, year of the event, height of inundation, duration of water logging and elevation of building from ground level were collected. For fire, year of the event, cause of fire and location of kitchen were recorded. Information about cracks developed in the buildings were collected. It includes shape of the cracks, width of crack and building element on which this crack appears. These details about cracks can help to identify the problem due to which these cracks appear.

At the end of the format latitude/ longitude of the location and 3 photographs were taken for each building.

To estimate the economic losses in the building and unit cost of reconstruction, data about cost of construction material (sand, cement, brick, aggregate etc.) and labour cost were also collected for each village or town area.

7.2 Development of RVS reference guide and Field guide book:

RVS reference guide and field guide book were prepared by TARU to facilitate the integrated RVS process. RVS reference guide describes all the technical terms used in the format and details of the each question of the format in a sequence. A field guide book was also prepared about Do's and Don'ts in the field and selection of building for RVS. Rules for selection of building for RVS were clearly mentioned in the field guide book so that neighboring houses can be avoided and a good sampling of buildings can be obtained. Both reference manual and field guide book were given to surveyors to refer it during RVS.

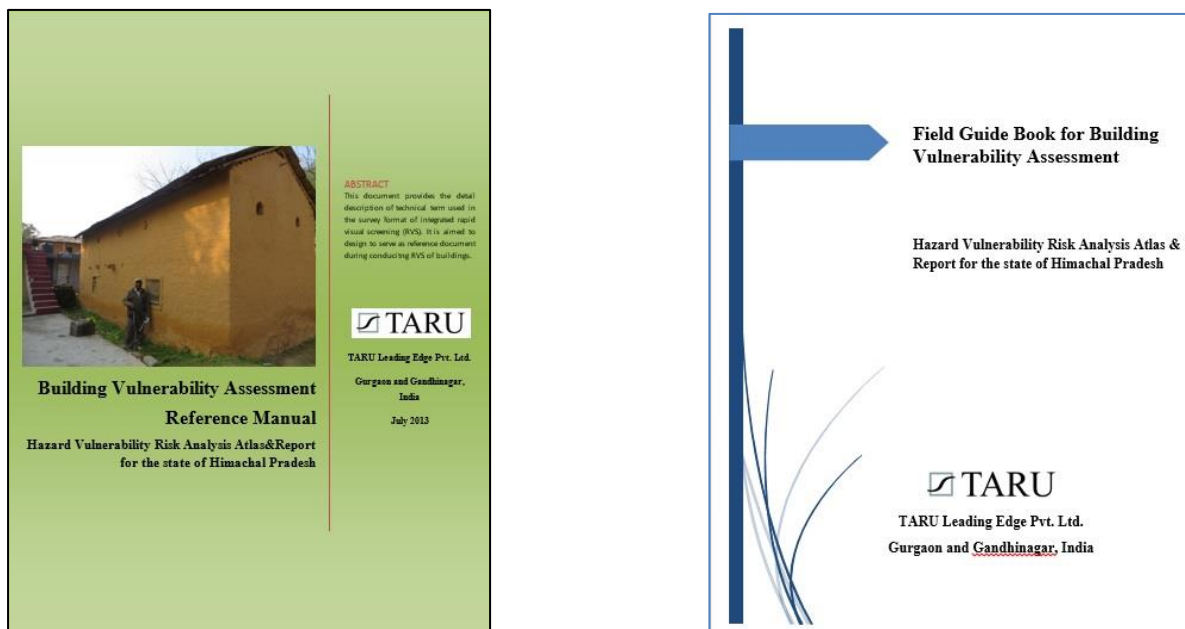

Figure 31: Reference Manual and Field Guide Book developed for RVS (TARU, 2013)

7.3 Design of integrated RVS format for tablet computers:

RVS format was designed for the android platform using ODK (Open Data Kit) framework. Tablet computer were used to install the RVS format which can be fetched directly from the server for filling the building data during RVS.

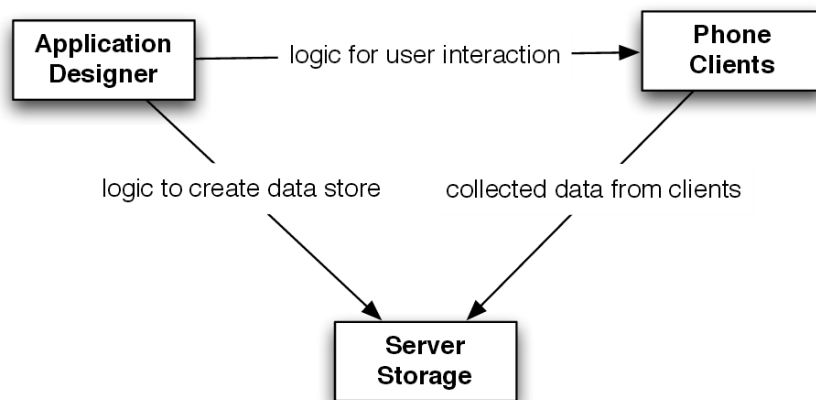

Figure 32: ODK (Open data Kit) Framework (Carl Hurtung 2010)

Open Data Kit is designed as a modular set of components that can be used individually or in various configurations (including modules that are not part of ODK) to create information services. ODK currently consists of three tools: Build, Collect and Aggregate (Figure 32)

ODK Build: It is a drag-and-drop application designer through which allows develop the survey forms for the system.

ODK Collect: It is a mobile platform through which allows to fetch the blank survey forms from the server and provide interface to the surveyors for fill up the forms. It also send the finalized (submitted) forms back to the server.

ODK Aggregate: It allows to collect the data on a server and extract it in useful formats for administrator to analyze information. It provides following functionality.

- Provide blank forms to ODK Collect.
- Accept finalized forms (submissions) from ODK Collect and manage collected data.
- Visualize the collected data using maps and simple graphs.
- Export data (e.g., as CSV files for spreadsheets, or as KML files for Google Earth)
- Publish data to external systems (e.g., Google Spreadsheets or Google Fusion Tables)

7.4 Training of Surveyors:

Rapid visual screening is technical survey and it should not be done by the person other than civil engineering background as it requires visual observation.

TARU contacted 2013 batch students of civil engineering diploma of government polytechnic Banikhet in Chamba district, MIT Hamirpur and Government Polytechnic Hamirpur. 15 diploma engineers were selected initially out of 45 students on the basis of the technical interview conducted in Mandi, Hamirpur and Kangra district. TARU expert provided a presentation to describe about the building vulnerability assessment

work and its importance for the state. Later some more surveyors were hired for conducting RVS. 22 surveyors have contributed in the RVS of buildings (Annexure 2). Surveyors were provided a 2 days training program in Hamirpur district of Himachal Pradesh from 16th -17th August 2013. First day was dedicated to classroom training which consist of sensitization of surveyors for showing the importance of BVA work, brief description of the project and detailed discussion of RVS format. Surveyors were also provided a BVA reference manual which consist of all technical terminology used in the integrated RVS survey format and concept along with figures. Day 2 was dedicated to field visit along with experts (Fig. 33). After demonstrating the use of RVS format for 2 buildings, surveyors were asked to conduct RVS of 2 buildings by their own. Their findings and queries were discussed again in the classroom. Surveyors were provided user guide book developed by TARU which describe the “Do’s and Don’ts” in the field work and rules for selection of buildings.

This training program was conducted by experts from NIT Hamirpur (Prof. Hemant Kumar Vinayak, Civil Engg. Department) and TARU (Mr. Shashank Mishra and Navneet Yadav). Apart from this training program, Prof. Hemant Kumar Vinayak, NIT Hamirpur also contributed previously in the development of RVS format and selection of institution for hiring surveyors for RVS work.



Figure 33: Field Training of Surveyors for BVA Survey (Hamirpur. 16-17th August 2013)

After 1 week of field work, surveyor’s meeting was held in Kangra on 28th August 2013 as part of data monitoring process. It helped in removing the conceptual error and improving the quality of data collection. Surveyors recruited at later stage of RVS went through 3 days onsite training program and telephonic interview before the final selection for conducting RVS.

7.5 Creation of Inventory of Building Vulnerability Database and Data Verification:

This section describes the procedure for creation of building vulnerability database. A mechanism has been setup to verify the data quality on regular interval.

7.5.1 Creation of Inventory of Building Vulnerability Database:

After designing RVS format for android platform, it is stored on all the tablet computers to be used for data collection. Once it is installed, it does not require internet connectivity to fetch the blank form. Data is collected from the field on day to day basis. On a regular basis, surveyors were provided maps of the marked area along with the number of buildings to be surveyed in that area.

Table 10: Different Steps of Data Collection Using Tablet Computer Based RVS Format

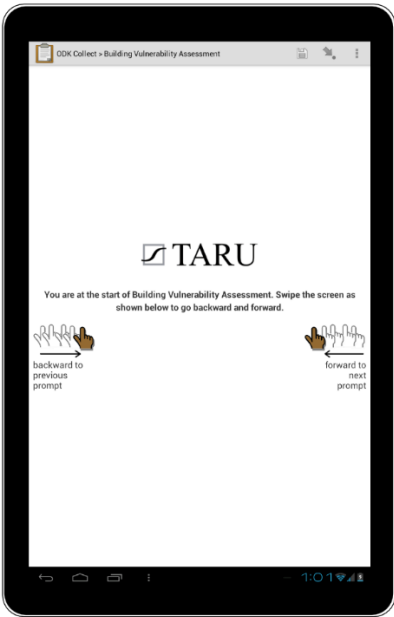
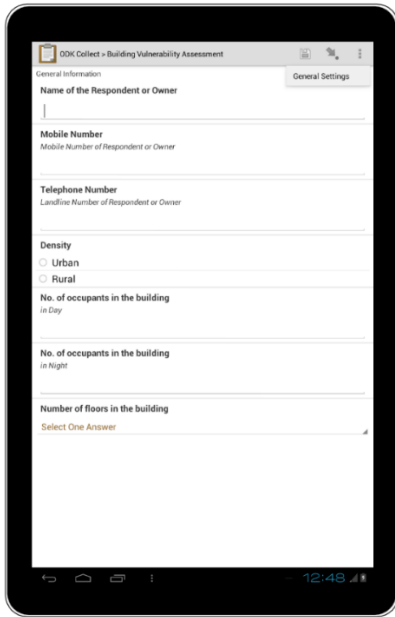
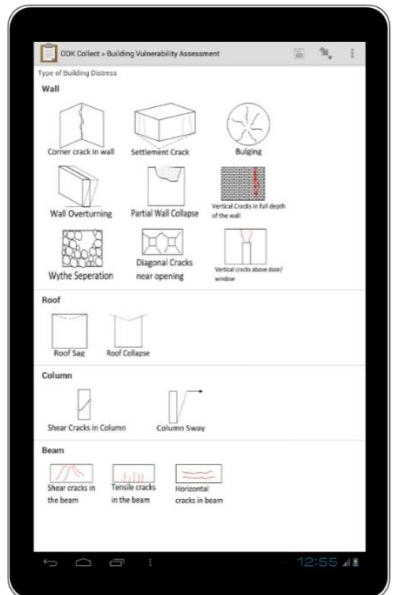
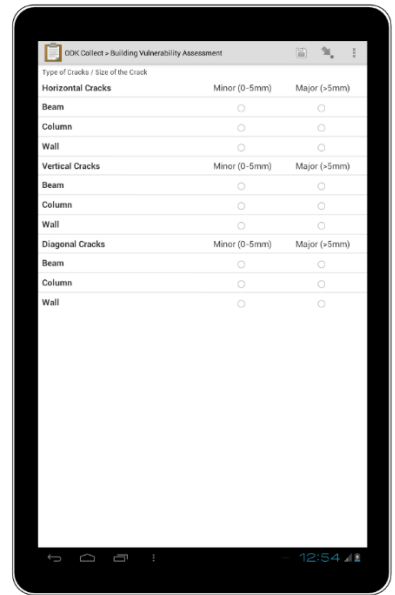
 <p>The screenshot shows the start screen of the ODK Collect app for Building Vulnerability Assessment. It features the TARU logo and instructions: "You are at the start of Building Vulnerability Assessment. Swipe the screen as shown below to go backward and forward." There are two hand icons with arrows pointing left and right, labeled "backward to previous prompt" and "forward to next prompt" respectively.</p>	 <p>The screenshot shows a form titled "General Information" with the following fields: "Name of the Respondent or Owner", "Mobile Number", "Telephone Number", "Density" (with radio buttons for Urban and Rural), "No. of occupants in the building In Day", "No. of occupants in the building In Night", and "Number of floors in the building".</p>																																							
 <p>The screenshot shows a grid of building distress types categorized into: "Wall" (Corner crack in wall, Settlement Crack, Bulging, Wall Overturning, Partial Wall Collapse, Vertical Cracks in full depth of the wall, Wythe Separation, Diagonal Cracks near opening, Vertical cracks above door/window), "Roof" (Roof Sag, Roof Collapse), "Column" (Shear Cracks in Column, Column Sway), and "Beam" (Shear cracks in the beam, Tensile cracks in the beam, Horizontal cracks in beam).</p>	 <p>The screenshot shows a form titled "Type of Cracks / Size of the Crack" with a table for recording data:</p> <table border="1"> <thead> <tr> <th>Type of Cracks / Size of the Crack</th> <th>Minor (0-5mm)</th> <th>Major (>5mm)</th> </tr> </thead> <tbody> <tr> <td>Horizontal Cracks</td> <td></td> <td></td> </tr> <tr> <td>Beam</td> <td><input type="radio"/></td> <td><input type="radio"/></td> </tr> <tr> <td>Column</td> <td><input type="radio"/></td> <td><input type="radio"/></td> </tr> <tr> <td>Wall</td> <td><input type="radio"/></td> <td><input type="radio"/></td> </tr> <tr> <td>Vertical Cracks</td> <td></td> <td></td> </tr> <tr> <td>Beam</td> <td><input type="radio"/></td> <td><input type="radio"/></td> </tr> <tr> <td>Column</td> <td><input type="radio"/></td> <td><input type="radio"/></td> </tr> <tr> <td>Wall</td> <td><input type="radio"/></td> <td><input type="radio"/></td> </tr> <tr> <td>Diagonal Cracks</td> <td></td> <td></td> </tr> <tr> <td>Beam</td> <td><input type="radio"/></td> <td><input type="radio"/></td> </tr> <tr> <td>Column</td> <td><input type="radio"/></td> <td><input type="radio"/></td> </tr> <tr> <td>Wall</td> <td><input type="radio"/></td> <td><input type="radio"/></td> </tr> </tbody> </table>	Type of Cracks / Size of the Crack	Minor (0-5mm)	Major (>5mm)	Horizontal Cracks			Beam	<input type="radio"/>	<input type="radio"/>	Column	<input type="radio"/>	<input type="radio"/>	Wall	<input type="radio"/>	<input type="radio"/>	Vertical Cracks			Beam	<input type="radio"/>	<input type="radio"/>	Column	<input type="radio"/>	<input type="radio"/>	Wall	<input type="radio"/>	<input type="radio"/>	Diagonal Cracks			Beam	<input type="radio"/>	<input type="radio"/>	Column	<input type="radio"/>	<input type="radio"/>	Wall	<input type="radio"/>	<input type="radio"/>
Type of Cracks / Size of the Crack	Minor (0-5mm)	Major (>5mm)																																						
Horizontal Cracks																																								
Beam	<input type="radio"/>	<input type="radio"/>																																						
Column	<input type="radio"/>	<input type="radio"/>																																						
Wall	<input type="radio"/>	<input type="radio"/>																																						
Vertical Cracks																																								
Beam	<input type="radio"/>	<input type="radio"/>																																						
Column	<input type="radio"/>	<input type="radio"/>																																						
Wall	<input type="radio"/>	<input type="radio"/>																																						
Diagonal Cracks																																								
Beam	<input type="radio"/>	<input type="radio"/>																																						
Column	<input type="radio"/>	<input type="radio"/>																																						
Wall	<input type="radio"/>	<input type="radio"/>																																						

Source: Screen Images (TARU, 2013)

After filling all the required information in the RVS format, latitude/ longitude is recorded by enabling inbuilt GPS in the tablet computer. 3 photographs are taken for each building type in which 2 photographs are taken as front and side elevation of the building and 3rd picture belongs to any major building vulnerability feature.

Data is sent to the server using internet connectivity. Data is transferred to the server located at TARU Gandhinagar office. This data can be assessed from anywhere using the web application. Surveyors sent the data everyday evening or next day (in case of non-availability of signal in the remote area) after finishing the work.

meta_instalceID	meta_start	meta_end	meta_username	meta_deviceid	group1_name	group1_mobile_number	group1_landline	group1_density	group1_occupants_day	group1_occupants_night	group1_floors	group2_geological_ha
uid:c40a5618-f113-4106-971c-06775ac9a07e	2013-08-21 08:49:13.467	2013-08-21 15:30:13.388	tab16	356262054631375	Ashok kumar	9736456572		Rural	4	1	1	Earthquak Landslide
uid:4b093ad1-6f72-42d7-aabd-a086b21180ae	2013-08-21 09:23:45.197	2013-08-21 09:44:13.476	tab16	356262054631375	Jolender kumar	9418456670		Rural	1	5	1	Earthquak Landslide
uid:a3efa2ae-0ea2-4299-88ad-39a57fa079f5	2013-08-21 09:56:23.504	2013-08-21 15:36:08.89	tab16	356262054631375	Parmod thakur	9736554963		Rural	1	4	1	Earthquak Landslide
uid:d8c3fa0-1677-441d-ac97-a8e1c4bd13b4	2013-08-21 10:14:04.318	2013-08-21 10:27:19.838	tab16	356262054631375	Raj kumari	9459803227		Rural	8	1	1	Earthquak Landslide
uid:609dfdc1-16b7-4825-b28a-01d28ba579f7	2013-08-21 10:38:32.75	2013-08-21 10:47:33.579	tab16	356262054631375	Suresh kumar	9736555445		Rural	1	4	1	Earthquak Landslide
uid:b24f3f7-162f-45b6-aa3c-c7c5f0216222	2013-08-21 10:54:30.503	2013-08-21 15:33:26.716	tab16	356262054631375	Rikhi kumar	9418663370		Rural	1	4	1	Earthquak Landslide
uid:6e945a3e-	2013-08-21	2013-08-21			Krishan							Earthquak

Figure 34: Data Collection on server

The screenshot shows a dropdown menu with the following options:

- meta_instalceID
- meta_start
- meta_end
- meta_username
- meta_deviceid
- group1_name
- group1_mobile_number
- group1_landline
- group1_density
- group1_occupants_day
- group1_occupants_night
- group1_floors
- group2_geological_hazards
- group2_hydro_meteorological_hazards
- group2_other_hazards
- group2_snow_deposition
- group3_flood_dampness
- group3_affected_by_flood
- group4_flood_year
- group4_flood_height_inundation
- group4_flood_duration
- group4_flood_damage_loss
- group5_affected_by_landslide
- group6_landslide_label
- group6_landslide_year
- group6_landslide_damage_loss
- group6_fire_label
- group6_fire_kitchen_unit

Figure 35: Data Download option from server on user need base

Data can be downloaded in CSV or KML format. Different filters such as a specified start or end date of RVS, any parameter of RVS format can be added for downloading the required data (Fig. 35). This web interface also provide the facility to map the different building data obtained using pie chart or bar chart (Fig. 36). KML file can be used in any GIS software to see the locations where RVS was carried out (Fig.37).

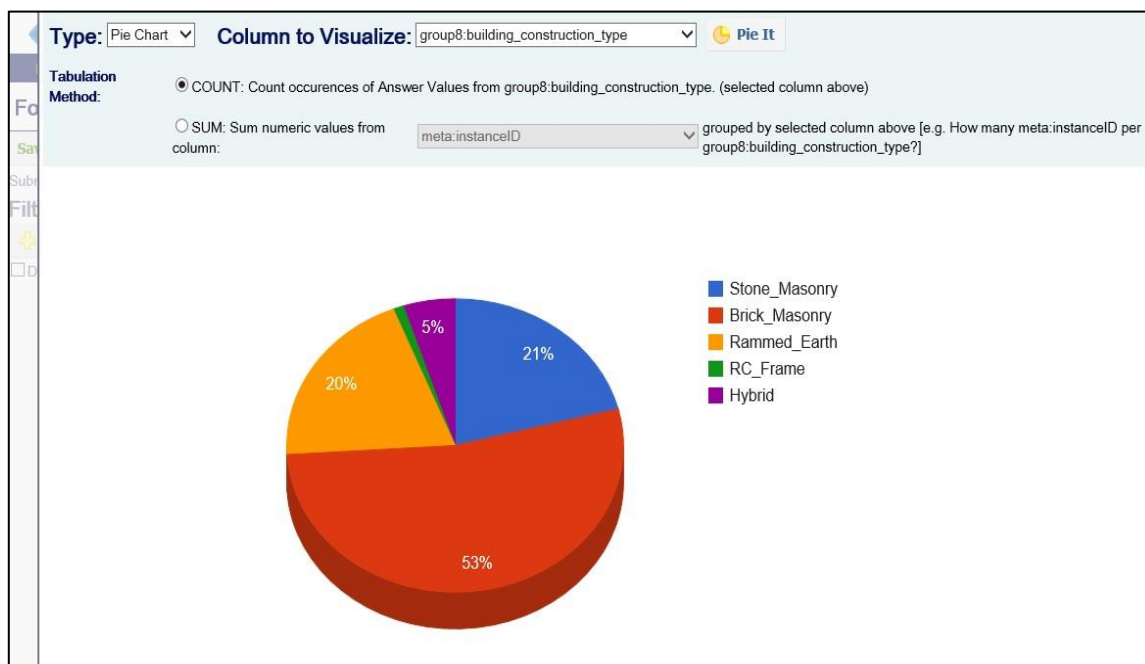

Figure 36: Visualization of selected parameter of collected building data directly on web

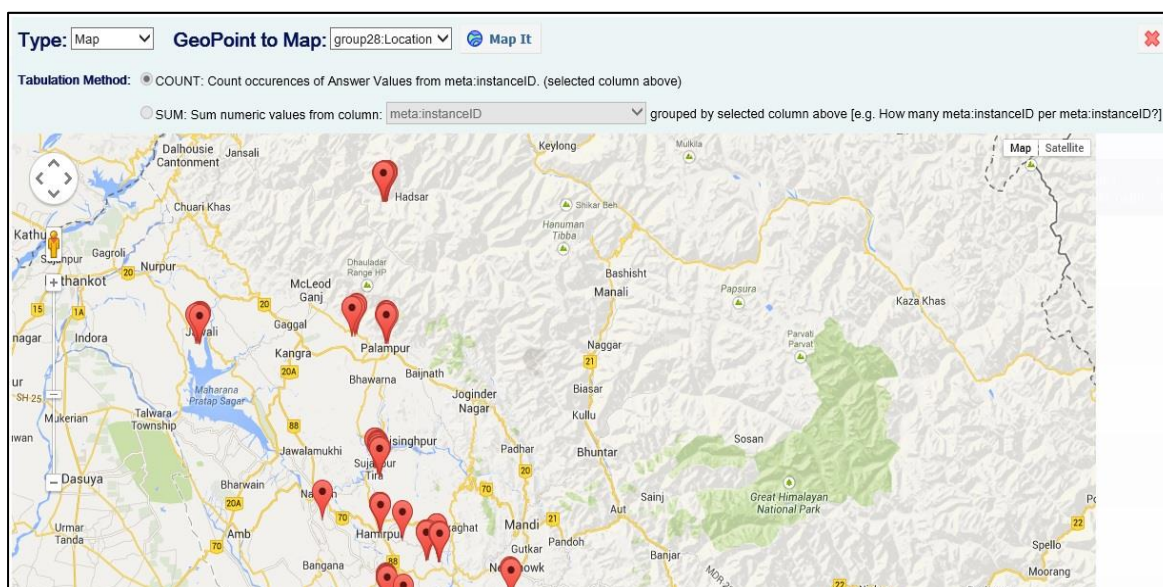

Figure 37: Map showing the locations of buildings for RVS

7.5.2 Mechanism for Verification of Building Vulnerability Data:

Following procedure is adopted for data verification:

1. Checking the start and end time of each survey to ensure that sufficient time (minimum 15 minutes) is given to do the building assessment.
2. Checking the time gap between two consecutive forms to ensure that adjacent buildings were not surveyed.
3. Calling surveyors randomly to discuss their technical errors found if any
4. Making 1 phone call to building owners per surveyor per day to check whether person visited the village/ place in reality.
5. Checking the data randomly to ensure that all the required technical information is provided and no column is left blank by mistake.
6. Doing the technical cross check of data. For example:
 - A building lying in flat or trough cannot be situated on slopes.
 - Checking the number of floors and then calculating the total built up area.
 - Type of staircase and diaphragm opening (Staircase situated outside building means there is no diaphragm opening)
 - Checking the dimensions of beam columns and walls
 - Checking the type of construction and building wall material
 - Checking the percentage of opening in any wall of the building corresponding to the number of building stories
7. Calling surveyors to discuss their errors in data and asking them to rectify for future work
8. Checking the photographs randomly to match the filled data

7.6 RVS scoring methodology:

Indian seismic zone is divided into four category i.e. Zone II, III, IV and V. Himachal Pradesh comes under the seismic zone IV and V. RVS scoring methods proposed in FEMA and METU are analyzed to see their applicability for Indian conditions. In RVS score method of USA designed by FEMA, a Pre-Code penalty is given for buildings designed and constructed before the enforcements of seismic codes. Similarly a Post-Benchmark positive attribute is assigned to buildings constructed after the enforcement of seismic codes. It has heavy reliance on the year of construction and effective enforcement mechanism of seismic codes in building construction assuming that the building would surely fulfill the codal requirement applicable at the time of construction. This is not true in cases of India where often seismic codes are not followed during construction due to absence of effective building code reinforcement mechanism.

Turkey has the similar situation and hence METU does not take into account the year of construction in defining the RVS score methodology. As building construction practices in India are much similar to Turkey, METU method was taken as base to develop rational method for RVS scoring of Indian buildings.

Basic structural score of the building is based on the type of seismic zone and number of storey in the building. India seismic zone map (IS1893:2002) is based on past experience or expected intensity of earthquake ground motion in different parts of the country. It does not address the seismic hazard in terms of peak ground acceleration or peak ground velocity. Indian seismic zone V (expected ground motion of IX and above on MSK intensity scale) is assigned same basic scores as for zone I of METU method,

zone IV (MSK intensity VIII) same as zone II of METU method and zone III (MSK intensity VII) & zone II (MSK intensity VI and lower) same as zone III of METU method.

The RVS score evaluation is based on a few parameters of buildings. The parameters of the buildings are building height, frame action, pounding effect, structural irregularity, short columns, heavy overhang, soil conditions, falling hazard, apparent building quality, diaphragm action etc. On the basis of above mentioned parameters, performance score of the buildings has been calculated. The formula of the performance score is given as

$$PS = (BS) + \sum[(VSM) \times (VS)]$$

Where VSM represents the Vulnerability Score Modifiers and VS represents the Vulnerability Score that is multiplied with VSM to obtain the actual modifier to be applied to the BS or Basic Score. For RC Frame building, the base score, vulnerability score and vulnerability modified score are given in table 11 & 12 whereas the same parameters for masonry buildings are given in table 13 and 14. A building with higher seismic zone and more number of storey will get the low score i.e. building will be more vulnerable.

The data analysis of the existing buildings in the region is scrutinized on the basis of Gaussian (Normal) distribution. This distribution is commonly used for statistical analysis of large data. A normal distribution in a variate X with mean μ and variance σ is a statistical distribution with probability density function:

$$f(x) = \frac{1}{\sigma\sqrt{2\pi}} e^{-\frac{(x-\mu)^2}{2\sigma^2}}$$

Generally a cumulative probability refers to the probability that the value of a random variable falls within a specified range. Frequently, cumulative probabilities refer to the probability that a random variable is less than or equal to a specified value. The cumulative Distribution function, which gives the probability that a variate will assume a value $\leq x$, is then

$$D(x) = \int_{-\infty}^x P(x)dx = \frac{1}{\sigma\sqrt{2\pi}} \int_{-\infty}^x e^{-\frac{(x-\mu)^2}{2\sigma^2}} dx$$

From these two it is very convenient to represent the probability that the performance score is less than or equal to some specified values under the curve.

Table 11: Base Scores (BS) and Vulnerability Scores (VS) for RC Frame Buildings in India

	Base Scores			Vulnerability Scores								
No. of Storeys	Seismic Zone V	Seismic Zone IV	Seismic Zone III or II	Frame Action	Soft Storey	Vertical Irregularities	Plan Irregularities	Short Column	Pounding	Soil Condition	Apparent Quality	Heavy Overhang

No. of Storeys	Base Scores			Vulnerability Scores								
	Seismic Zone V	Seismic Zone IV	Seismic Zone III or II	Frame Action	Soft Storey	Vertical Irregularities	Plan Irregularities	Short Column	Pounding	Soil Condition	Apparent Quality	Heavy Overhang
1 or 2	100	130	150	10	0	-10	-5	-5	0	10	-5	-5
3	90	120	140	10	-	-10	-5	-5	-2	10	-10	-10
4	75	100	120	10	20	-10	-5	-5	-3	10	-10	-10
5	65	85	100	10	25	-10	-5	-5	-3	10	-15	-15
>5	60	80	90	10	30	-10	-5	-5	-3	10	-15	-15

(Source: Sudhir K. Jain and Keya Mitra 2008)

Table 12: Vulnerability Scores Modifiers (VSM) for RC Frame Building in India

Frame Action	Does not exist = -1; Exists = 1, Not sure = 0
Soft Storey	Does not exist=0; Exists = +1
Vertical Irregularity	Does not exist=0; Exists = +1
Plan irregularity	Does not exist=0; Moderate = +1, Extreme=+2
Short Columns	Does not exist=0; Exists = +1
Pounding Effect	Does not exist=0, Non-aligned Floors=+2, Poor apparent quality of adjacent buildings = +2
Soil condition	Medium=0, Hard =1, Soft = -1
Apparent quality	Good=0, Moderate=+1, Poor=+2
Heavy Overhang	Does not exist=0; Exists = +1

(Source: Sudhir K. Jain and Keya Mitra 2008)

Table 13: Base Scores (BS) and Vulnerability Scores (VS) of Masonry Buildings in India

No. of Storeys	Basic Scores			Vulnerability Scores									
	Seismic Zone V	Seismic Zone IV	Seismic Zone III or II	Soil Condition	Apparent Quality	Structural Irregularities	Wall Openings	Wall Orientation	Horizontal Bands	Arches	Diaphragm Action	Rubble Masonry	Pounding
1 or 2	100	130	150	10	-10	-10	-5	-2	20	-10	10	-15	0
3	85	110	125	10	-10	-10	-5	-5	20	-10	10	-15	-3
4	70	90	110	10	-10	-10	-5	-5	20	-10	10	-15	-5
5	50	60	70	10	-10	-10	-5	-5	20	-10	10	-15	-5

(Source: Sudhir K. Jain and Keya Mitra 2008)

Table 14: Vulnerability Scores Modifiers (VSM) for Masonry Buildings in India

Soil conditions	Medium=0, Hard=+1, Soft = -1
Apparent quality	Good=0, Moderate=+1, Poor=+2
Structural Irregularities	Absent/Do not know=0; Exists=+1
Wall openings	Small=0, Moderate=+1, Large=+2
Opening Orientation	Regular=0, Less regular=+1, Irregular=+2
Horizontal Bands	Present=+1, Absent=-1, Do not know=0
Arches	Present=+1, Absent/ Do not know=0
Diaphragm Action	Present/Do not know=0, Absent=-1,
Random Rubble Stone Masonry	Present=+1, Absent = 0
Pounding Effect	Does not exist=0, Poor quality of adjacent buildings=+2

(Source: Sudhir K. Jain and Keya Mitra 2008)

7.7 Parameters for performance score evaluation:

Parameters selected for computing the RVS score or Performance score are described in detail in this section. Some parameters are similar in the computation of RVS score for both RC frame and brick masonry building such as number of floors, type of seismic zone, soil condition, pounding effect and apparent quality of structure. Other parameters for RC frame include frame action, soft storey, vertical and plan irregularity, short column and heavy overhang. For brick masonry structures, other parameters such as structural irregularities, wall opening, wall orientation, horizontal bands, arches and diaphragm action are also taken into account.

7.7.1 Number of Floors

This is the total number of floors above the ground level. The buildings were generally residential, although some were commercial and some mixed use involving residential accommodation above ground floor commercial premises.

7.7.2 Structural Irregularities

Properly distributed lateral load resisting elements within the building lead to a regular structural configuration and better seismic performance. The structural walls should be uniformly distributed in both orthogonal directions of the building. They should be sufficient in number and strong enough to resist the expected seismic loads. In masonry buildings, horizontal vibrations can be most damaging, especially in situations where adequate walls are not present in both the orthogonal directions, or when the walls are not properly joined to adjacent walls. In low income residential areas, having small and narrow plots the houses may have two parallel walls in one direction only, with fewer walls in the perpendicular direction. In deep plots located in commercial areas, with comparatively narrow frontages, it is quite common in India to find buildings with walls only at the two ends along the long directions and no walls in the other direction, to

accommodate clear floor space for display or storage. Such buildings are clearly very vulnerable. Figure 38 shows presence of structural irregularities in the building.



Figure 38: Structural irregularities are present in the building at Kangra district

7.7.3 Heavy Overhangs:

Heavy overhangs are formed when projections of the actual habitable spaces, from the first floor upwards, are made to increase the available floor area in the upper floor tenements. Buildings having such large and heavy cantilever projections have been observed to sustain heavy damage in earthquake events. Heavy balconies and overhanging floors in multistory reinforced concrete buildings shift the mass center upwards; accordingly give rise to increased seismic lateral forces and overturning moments during earthquakes. Heavy balconies and overhanging floors in reinforced concrete buildings shift the mass center upwards; accordingly increase seismic lateral forces and overturning moments during earthquakes. Buildings having balconies with large overhanging cantilever spans enclosed with heavy concrete parapets sustained heavier damages during the earthquakes compared to regular buildings in elevation. Since this building feature can easily be observed during a walk-down survey, it is included in the parameter set. Large cantilevers (projections supported only on one side) especially at upper floors are undesirable. Figure 39 shows presence of heavy overhangs on the top of building.



Figure 39: Heavy overhangs are present on the top of structure at Kangra district

7.7.4 Re-entrant Corners:

The re-entrant, lack of continuity or “inside” corner (fig. 40) is the common characteristic of overall building configuration that, in plan, assume the shape of an L, T, H, +, or combination of these shapes. The dimension of the offset and the proportion of the derived wings will determine the vulnerability of a building. Each wing will react to the displacements and the torsional effects produced by ground motions in a different way. Under the action of earthquake forces, each wing will have a different dynamic behavior because of its particular stiffness and position relative to the direction of horizontal forces. The movement of different parts of the building can be very complicated, producing considerable diaphragm deformation, torsional effects and concentration of stress at the vertices of reentrant corners.

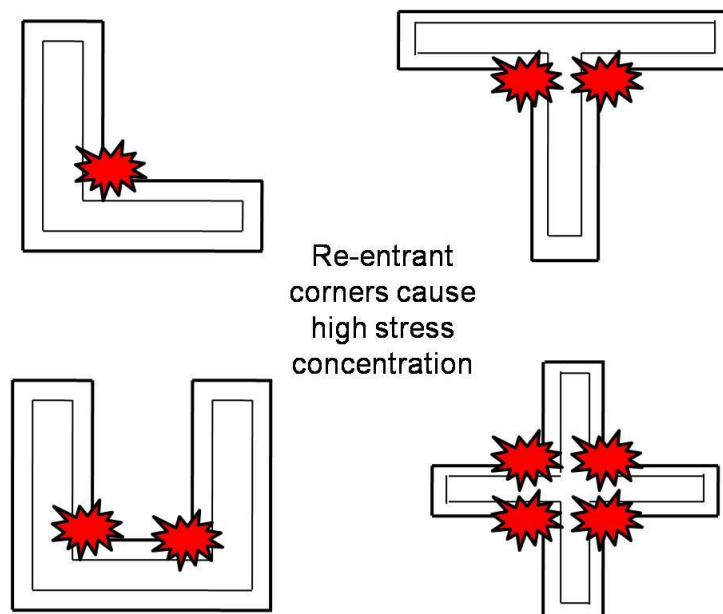

Figure 40: Re-entrant corners in buildings

7.7.5 Local Soil Conditions:

The intensity of ground motion at a particular site predominantly depends on the distance the causative fault and local soil conditions. There exists a strong correlation between Peak Ground Velocity (PGV) and the shear wave velocities of local soils. Site amplification is one of the major factors that increase the intensity of ground motions. Although it is difficult to obtain precise data during a street survey, an expert observer could be able to classify the local soils as stiff or soft. The geotechnical data provided by local authorities is a reliable source for classifying the local soil conditions. The risk of building increases, as the softness of soil increases. If the soil is sandy and is saturated with ground water, there is a possibility of liquefaction during earthquakes as the soil loses its firmness and behaves as a jelly.

7.7.6 Pounding:

Pounding is damage caused by two buildings, or different parts of a building, hitting one another. The number of buildings damaged by pounding is small. Pounding is the result of irregular response of adjacent buildings of different heights and of different dynamic characteristics. In situations where two buildings are located too close to each other, they may collide during strong shaking leading to substantial damage. The pounding effect is more pronounced in taller buildings. When building heights do not match, the roof of the shorter building may pound at the mid-height of the columns in the taller building; this can be quite dangerous, and can lead to story collapse.

7.7.7 Diaphragm Action:

The diaphragm configuration is the shape and arrangement of horizontal resistance elements that transfer forces between vertical resistance elements. Diaphragms perform a crucial role in distributing forces to the vertical seismic resisting elements. The diaphragm acts as a horizontal beam, and its edges act as flanges. Geometrical irregularities are analogous to such irregularities in other building elements, leading to torsion and stress concentration. The horizontal inertia forces generated by the ground motion at different locations of the floor must be transferred to the vertical elements such as walls. For this, the floor must act as a diaphragm. Cast-in-situ reinforced concrete or reinforced brick slabs are quite effective as diaphragms. However, other types of floors such as timber, if not properly connected together, for seismic loading, may not provide the diaphragm action. Discontinuities in the diaphragm due to the presence of large cut outs hinder the ability of the diaphragm to transfer lateral forces to the walls. Diaphragms cannot be determined from building exteriors during rapid visual screening surveys and may be observed only if access to a building is possible. The same is true of cut outs in diaphragms. Considering the importance of proper diaphragm action in the seismic performance of buildings, a penalty modifier of -10 is proposed in situations where absence of proper diaphragm action can be confirmed. No modifiers are proposed for situations where diaphragm action is either present or undeterminable through visual screening alone.

7.7.8 Soft/weak stories:

A soft or weak storey is created when the lateral stiffness and/or strength of a storey is markedly more flexible than the floors above and below. This often occurs at the ground

floor when it is left open for parking, a shop front, or other reasons. Most of the deformation demand from the seismic event is concentrated at this level and results in large rotation demand in columns that have not been designed for ductility. Soft/weak storey collapses have been seen in many past earthquakes. Soft story usually exists in a building when the ground story has less stiffness and strength compared to the upper stories. This situation mostly arises in buildings located along the side of a main street. The ground stories, which have level access from the street, are employed as a street side store or a commercial space whereas residences occupy the upper stories. These upper stories benefit from the additional stiffness and strength provided by many partition walls, but the commercial space at the bottom is mostly left open between the frame members, for customer circulation. Besides, the ground stories may have taller clearances and a different axis system causing irregularity. The compound effect of all these negative features from the earthquake engineering perspective is identified as a soft story. Many buildings with soft stories were observed to collapse due to soft story in the past earthquakes all over the world.

7.7.9 Short Column Failure:

A short column failure is caused by its relatively high stiffness in comparison to other columns at that floor level. The transverse forces generated at a floor level are distributed in proportion to the member stiffness, therefore a short column will attract a greater proportion of the load and, when compared to a more slender member, will have less ability to withstand the deflections that will occur over their height. Frames with partial infill lead to the formation of short columns which sustain heavy damage since they are not designed for the high shear forces due to shortened heights that will result from a strong earthquake. Semi-in-filled frames, band windows at the semi-buried basements or mid-story beams around stairway shafts lead to the formation of short columns in concrete buildings. These captive columns usually sustain heavy damage during strong earthquakes since they are not originally designed to receive the high shear forces relevant to their shortened lengths. Short columns can be identified from outside because they usually form along the exterior axes.

7.7.10 Frame Action:

Load transfer means to support the loads acting on the building and to safely carry them down to the soil below. In a framed building, the loads are transferred by 'Frame Action'. First the loads are transferred from slabs to beams. Beams then transfer them to columns immediately below them. These columns transfer the loads to lower columns. While a beam carries the load for that floor only, a column carries the load for all the floors above it. The lowermost columns transfer the loads to the foundation, which, in turn, transfers them to the soil.

7.7.11 Falling Hazards:

Presence of various non-structural components such as air conditioning units, parapets and advertisement hoardings can cause injury to pedestrians as well as to building occupants and contents during an earthquake, even though these may not have implications for the overall structural safety of the building. These are important because they can and do contribute to earthquake related losses as is evident from instances of chemical spills, breakage to building contents, misalignment of piping, etc.

Falling hazards include mechanical and electrical equipment, piping and ducting, unsecured masonry parapets, and eccentrically placed water tanks on top of the building. A slab or a beam supported only on one side and projecting horizontally on the other side is called a 'Cantilever' slab or beam e.g. balconies, lofts and canopies. Figure 41 shows location of falling hazards in a building.



Figure 41: Falling hazards in a building

7.7.12 Vertical Irregularities:

Vertical building should also be vertically regular to increase the building safety during earthquakes. There should not be any discontinuation in the path of load transfer from top of the structure to the supporting foundation. For this purpose all columns and walls should run throughout the height of the structure. Any discontinuity in the load transfer can cause potential damage to the structure. Open ground storey for car parking is one type of vertical irregularity. This sudden change in the stiffness causes the extreme stresses in the columns of ground storey which can lead to the catastrophic failure of columns that lead to the collapse of upper floors.

Setback and stepback in the buildings can also be seen which is termed as the vertical irregularity. Buildings with cantilever projection of the building on the upper floor or step back in the subsequent floors are more vulnerable in earthquake.

7.7.13 Apparent Quality:

Quality of construction has a significant impact on the seismic performance of the building. However it is difficult to judge the apparent quality of the building, a certain observation can be made to assess the current condition of the building. These observation include seepage, corrosion of steel, spalling of concrete, structural cracks developed in the building element. It can be assumed that building showing above signs would have received poorer quality of construction originally as compared to the

buildings that look better. Age of building also affect the level of corrosion and concrete damage.

7.7.14 Wall opening:

Opening in the wall reduces the stiffness of the wall. Openings are functional requirement of the building but their spacing and location affect the performance of the building. Masonry walls are load bearing wall and they must have good interlocking at the corner. Opening near the corner of the wall reduces the flow of forces from one wall to another and hence they must be located away from the corners. Opening size should be kept as small as possible to avoid the reduction in the stiffness and load carrying capacity of the walls.

7.7.15 Horizontal band:

In masonry buildings, it is mandatory to provide the horizontal bands in the buildings lying in the seismic zone IV and V to make them safe against earthquake. Horizontal bands of reinforced concrete should be provided at plinth, sill, and lintel and roof level in all the walls. These bands help to keep the walls intact like a box structure and reduces the probability of out of plane movement of the wall during earthquake shaking. Horizontal band reduces the unsupported height of the wall and thus improve their stability in weak direction. In flat roof buildings, separate roof band is not requires as flat roof act as roof band but roof band must be provided for sloped roofing like gable roof, hip roof etc. In sloped roofing, other band such as gable band is also provided.

7.8 Rapid Visual Screening of Buildings:

Rapid visual screening of buildings was conducted by building surveyors across the state in both rural and urban areas. Total 9099 buildings were surveyed in this process as a first step towards assessing their vulnerability for multiple hazards like earthquake, flood, landslide and fire. All the buildings were classified into five major type of construction i.e. Brick Masonry, Stone Masonry, RC Frame, Rammed Earth and Hybrid. Out of total sample of 9099 buildings, 48% buildings are brick masonry while Stone Masonry, RC Frame, Hybrid and Rammed Earth buildings feed 15%, 17%, 14% and 6% respectively (Figure 42).

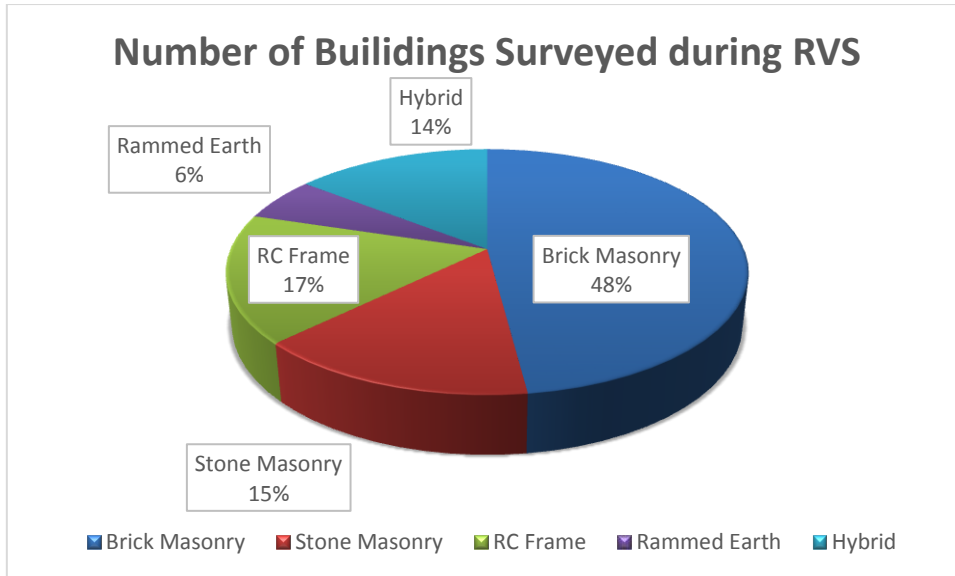

Figure 42: Number of Buildings surveyed during RVS (TARU Analysis 2014)

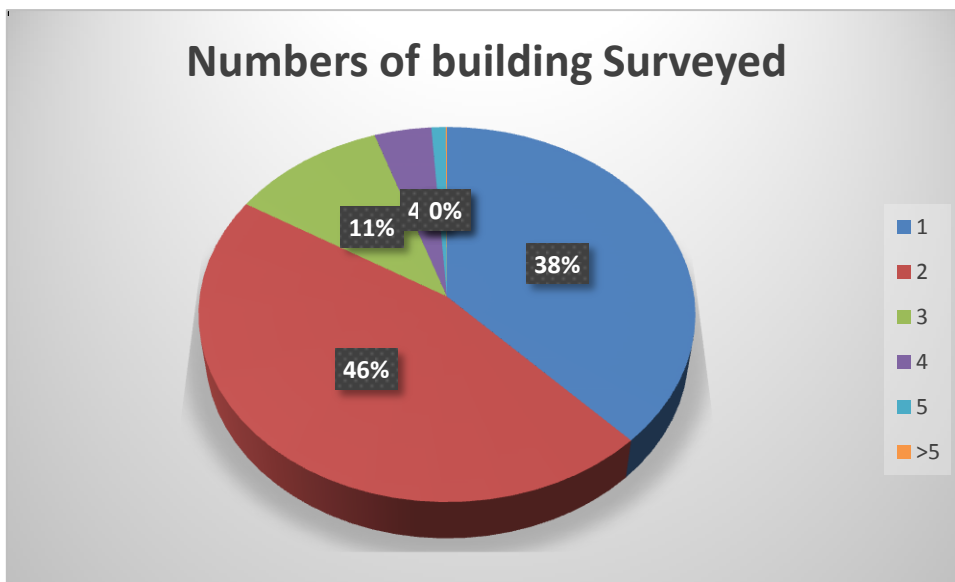

Figure 43: Building surveyed by number of storey

Buildings surveyed during RVS were mostly single (38%) or double storied (46%) buildings. 3 and 4 story buildings make the proportion of 11% and 4% (figure 43). Figure 44 shows the number of buildings in each district for which RVS was carried out.

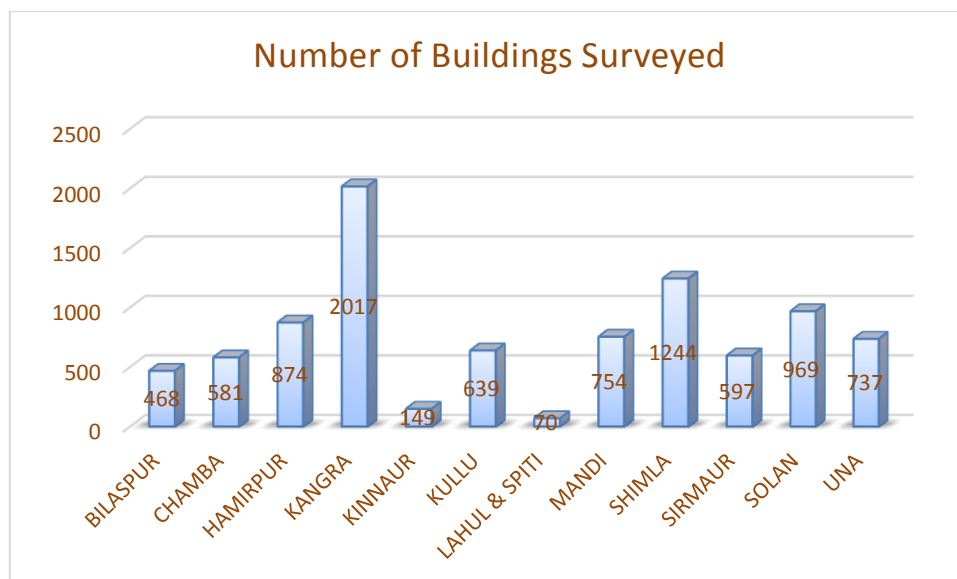

Figure 44: Number of Buildings surveyed in RVS

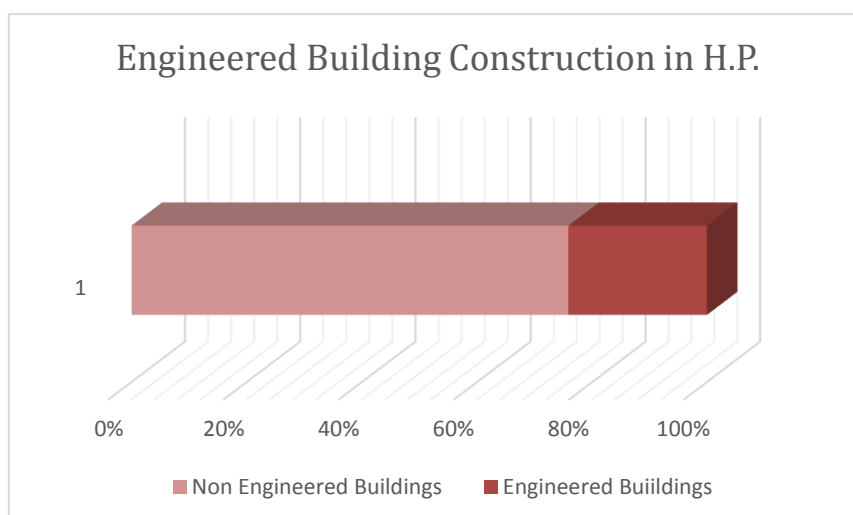

Figure 45: Engineered/ Non-engineered Building Construction in H.P. (Sample Size: 9099 buildings)

During RVS, it was determined that mostly buildings were built on the basis of traditional and local knowledge of house owner and masons without approved by any certified institution/ structural engineer. 75% buildings were found to be non-engineered buildings in comparison to 25% engineered buildings (figure 45) which mainly consist of hospitals, government offices or commercial buildings.

Table 15: Number of Buildings surveyed during RVS

District	Brick Masonry	Hybrid	Rammed Earth	RC Frame	Stone Masonry	Grand Total
BILASPUR	188	84	15	70	111	468
CHAMBA	220	98	38	96	129	581
HAMIRPUR	384	69	124	161	136	874
KANGRA	942	257	177	367	274	2017

District	Brick Masonry	Hybrid	Rammed Earth	RC Frame	Stone Masonry	Grand Total
KINNAUR	38	34	1	46	30	149
KULLU	380	86	51	57	65	639
LAHUL & SPITI	31	19	0	7	13	70
MANDI	390	93	39	99	133	754
SHIMLA	739	152	21	231	101	1244
SIRMAUR	315	99	44	36	103	597
SOLAN	455	144	7	267	96	969
UNA	280	184	9	105	159	737

Building samples were taken in proportion of population of districts. Maximum buildings were surveyed in Kangra (2071 buildings) followed by Shimla (1244 buildings) while lowest buildings -samples were scrutinized in Lahul-Spiti (70 Buildings) and Kinnaur (149 Buildings) due to most of the uninhabited land in these districts (Table 15).

Numerous buildings vulnerability parameters were included in RVS procedure along with questions related to building distress. Type of cracks and their width were recorded which helped to understand the reason behind development of those cracks. Apart from structural elements, non-structural elements were also recorded which create a major risk for both human life and economic exposure.

Age of Construction:

Building survey during RVS reveals the fact that most of the brick masonry and RC frame building construction took place in last two decades. Stone masonry construction were prominent in last 2nd and 3rd decades in last 50 years.

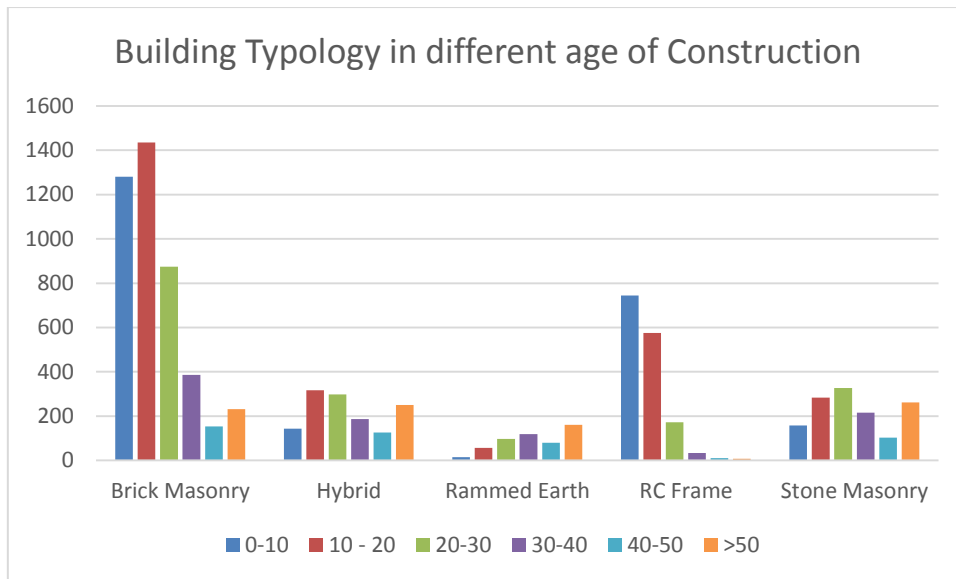

Figure 46: Trend of Building Typology in Different Age of Construction (Sample taken: 9099 buildings)

Rammed earth buildings were started decreasing in the subsequent years from 1960 onwards (figure 46). Last decade has also seen decrease in hybrid construction with the more number of newly built brick masonry and RC frame structures.

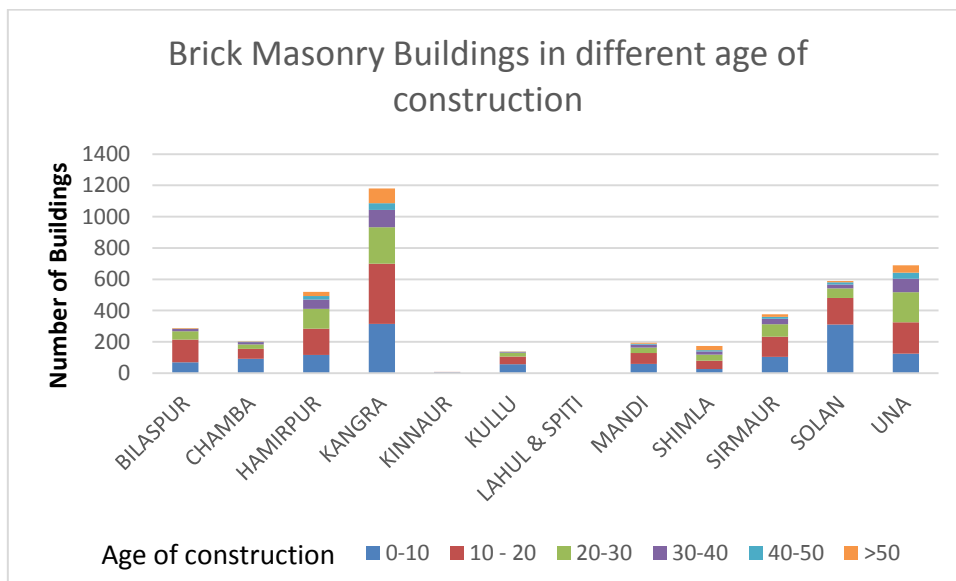

Figure 47: Brick Masonry Buildings of different age of construction

Figure 47 shows that in last two decades, brick Masonry construction was increased significantly in all the districts of Himachal Pradesh while stone masonry structures were found 20-50 years old in almost all the districts (figure 48). Una is the only district where no stone masonry building was found during RVS.

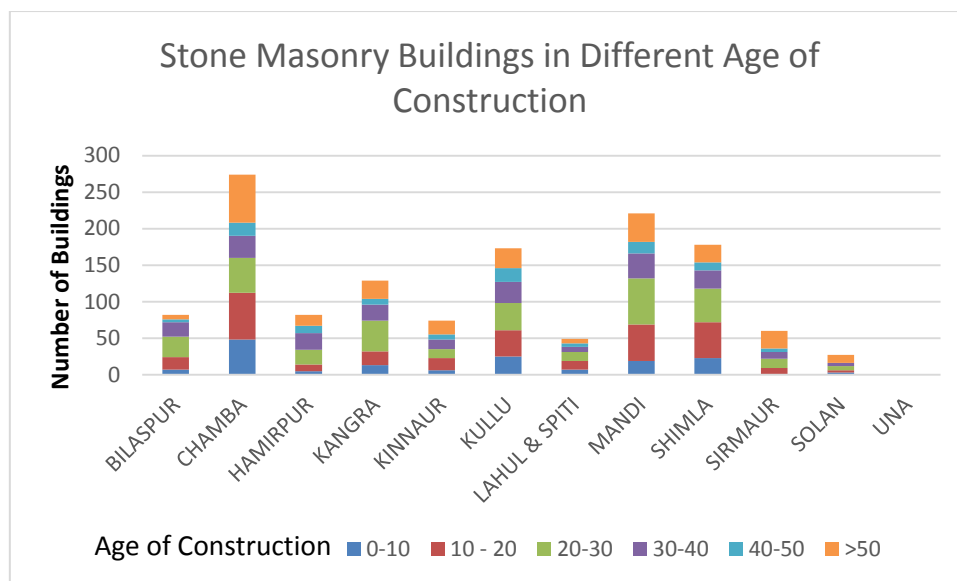

Figure 48: Stone Masonry Buildings of different age of construction

Construction of RC frame buildings have seen a sharp rise in the districts of Shimla, Solan, Kullu, Kangra and Mandi (figure 49). 20 years before very few RC frame buildings were constructed in the state. Construction of RC frame building only gains a momentum in last two decades after 1990. Very few RC frame buildings were observed in Chamba, Lahul and Spiti, Kinnaur and Una.

Rammed Earth buildings were mostly built in three districts i.e. Hamirpur, Kangra and Mandi. Rammed earth/ mud buildings were mostly found atleast 20 years old (figure 50). A sharp decrease was noticed in the construction of hybrid buildings during last decade. It was a common practice to build these buildings from combination of locally available material. It can be concluded that 20 years before (before 1990) stone masonry, rammed earth/ mud buildings and hybrid buildings were constituting the large part of the building infrastructure in the state. After 1990 due to growth in urban population and industrial growth, new construction technique like brick masonry and RC frame buildings were adopted as they require less maintenance cost and consume less time to construct. Improved road condition and their connectivity to even the remote areas/villages reduces the transportation cost of the construction materials like brick, cement, sand and steel which increased rapidly brick masonry and RC frame construction.

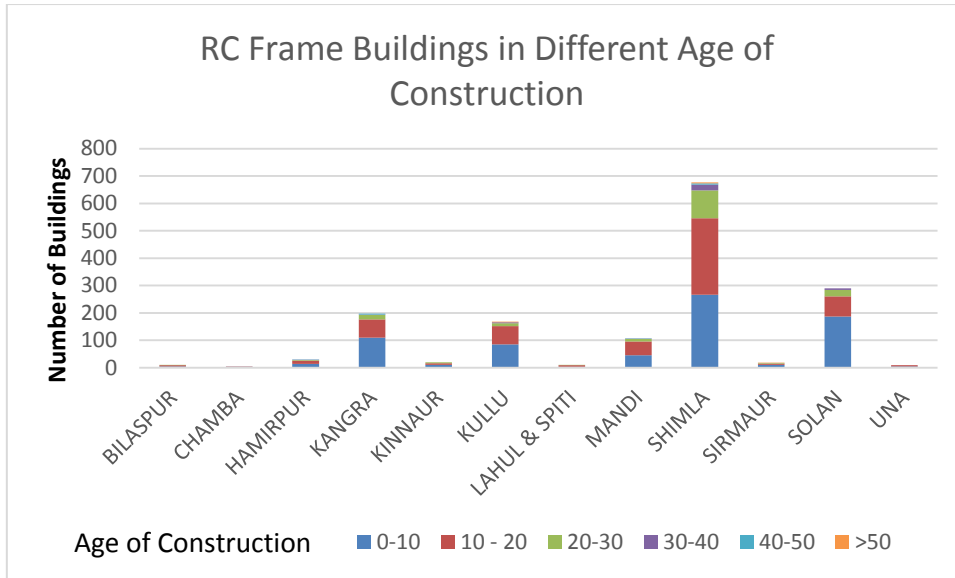

Figure 49: RC Frame Buildings in Different Age of Construction

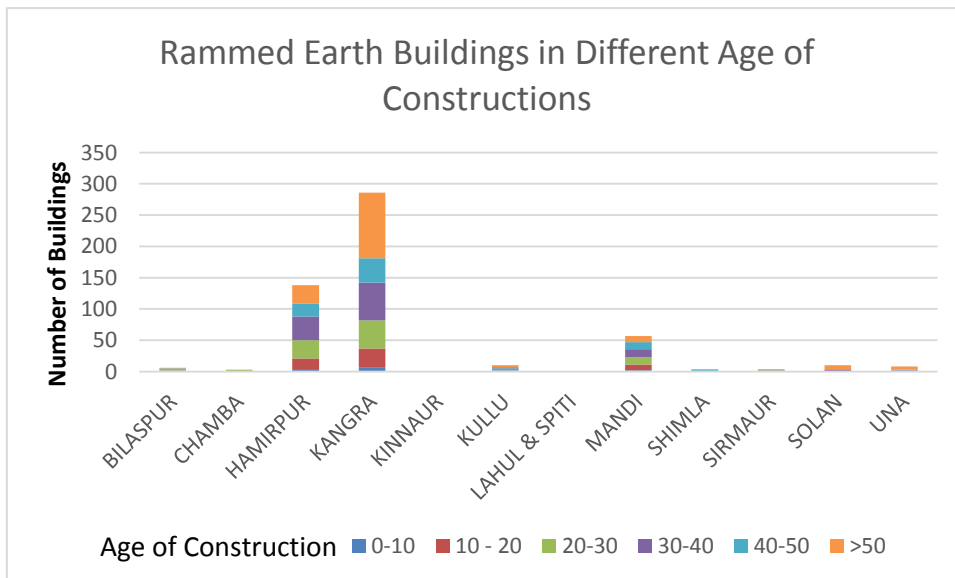

Figure 50: Rammed Earth Buildings in Different Age of Construction

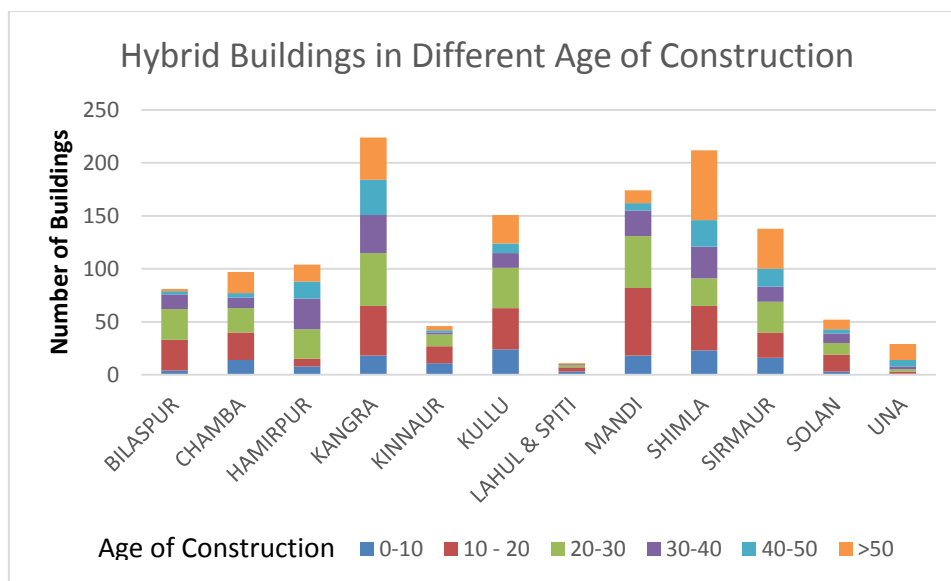

Figure 51: Hybrid Buildings in Different Age of Construction

7.8.1 Educational Institute:

578 educational institute were screened during RVS which include 122 Aanganwadi Kendra, 45 colleges and 411 schools (Table 16). Mostly Aanganwadi centers do not have their own building and they mostly run in the residential buildings. Most of the schools and Anagawandi Kendra are more than 30 years of old brick masonry / stone masonry structures which do not have any seismic safety features. Age of the construction does not play a major role in vulnerability of building as old buildings were mainly built with local material and traditional knowledge and thus provide a better resistance. More than 50% educational institute are classified under medium vulnerability which can sustain sufficient damage depend upon the peak ground acceleration of that particular site (table 18 & figure 53).

Table 16: Type of Construction in Educational Institute

Type of Construction	Aanganwadi	college	school
Brick Masonry	89	4	219
Hybrid	8	6	50
Rammed Earth	8		11
RC Frame	4	22	43
Stone Masonry	13	13	88

Table 17: Type of Education Institute and their Age of Construction (Sample: 578 buildings)

Age of Construction	Aanganwadi	college	school
0-10	32	10	75

10 - 20	43	13	127
20-30	23	12	85
30-40	17	5	35
40-50	4	1	25
>50	3	4	64

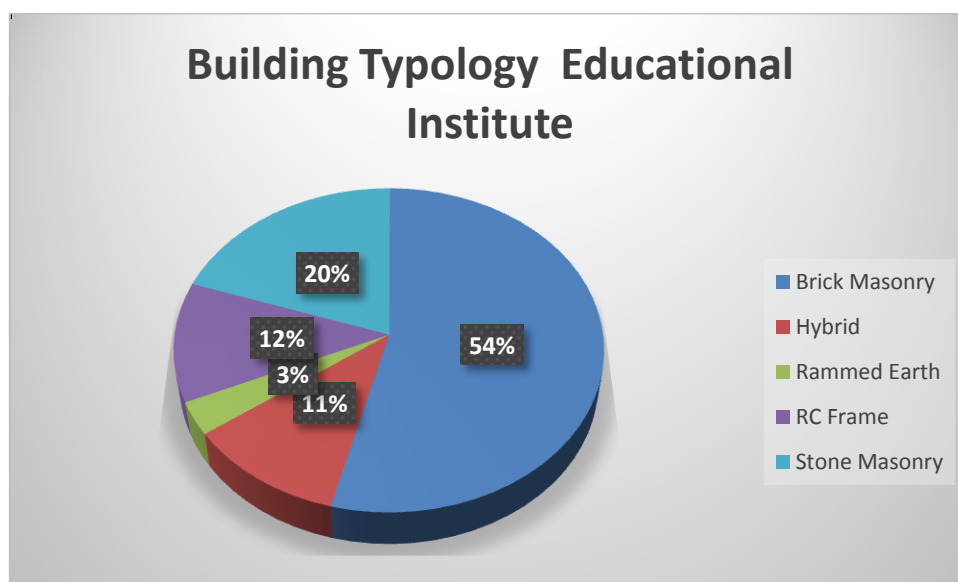

Figure 52: Building Typology of Educational Institute

Table 18: Vulnerability of Educational Institute with respect to their age of construction

Age of construction (yrs)	0-10	10 - 20	20-30	30-40	40-50	>50
high (RVS≤80)	9	23	7	3	6	6
medium (80<RVS≤120)	72	109	77	40	17	45
low (RVS>120)	36	51	34	14	7	20
Total	117	183	118	57	30	71

Table 19: Vulnerability of Different type of Educational Institute

RVS Score	Aanganwadi	School	College	Vulnerability
RVS≤80	13	34	9	high
80<RVS≤120	71	256	33	medium
RVS>120	38	121	3	low

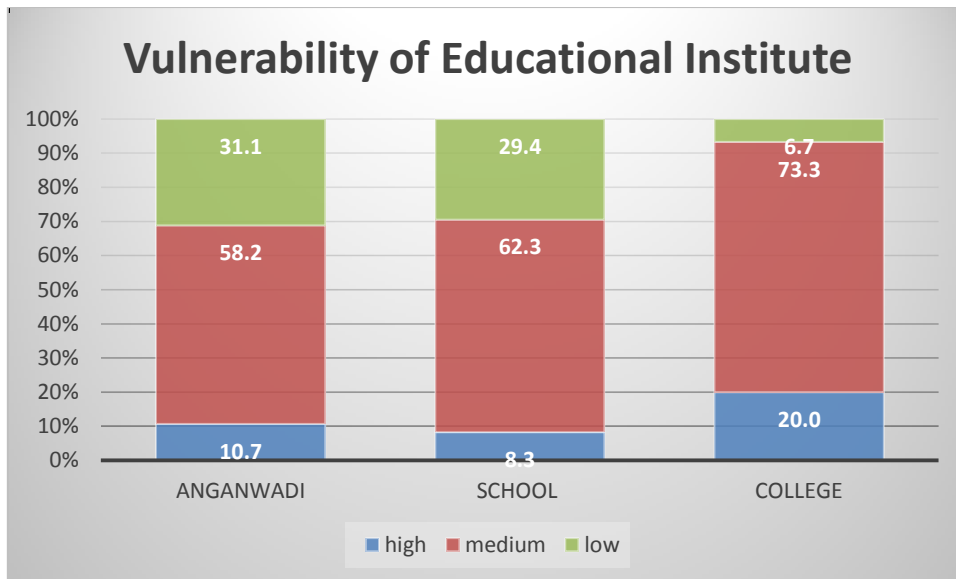

Figure 53: Percentage of Educational Buildings under different level of Vulnerability (Sample : 578 buildings)

Most of the colleges were either RC frame structure (new) or stone masonry structure (old). Interestingly higher percentage of colleges were found to be medium to high vulnerable which are mostly RC frame construction. It means that modern construction practice of RC frame buildings can be safe only with the proper code compliance and good workmanship. Construction deficiencies, poor quality control and workmanship can result into highly vulnerable buildings.

7.8.2 Health Institutions:

Total 128 health institutions were surveyed during RVS of buildings in the state which include 42 hospitals and 86 community health centres (Table 20).

Table 20: Building typology of Health Institutions

Health Institutions	Total	BM	SM	RC Frame	Hybrid
Community Health Centre	42	7	23	11	1
Hospitals	86	18	42	21	5

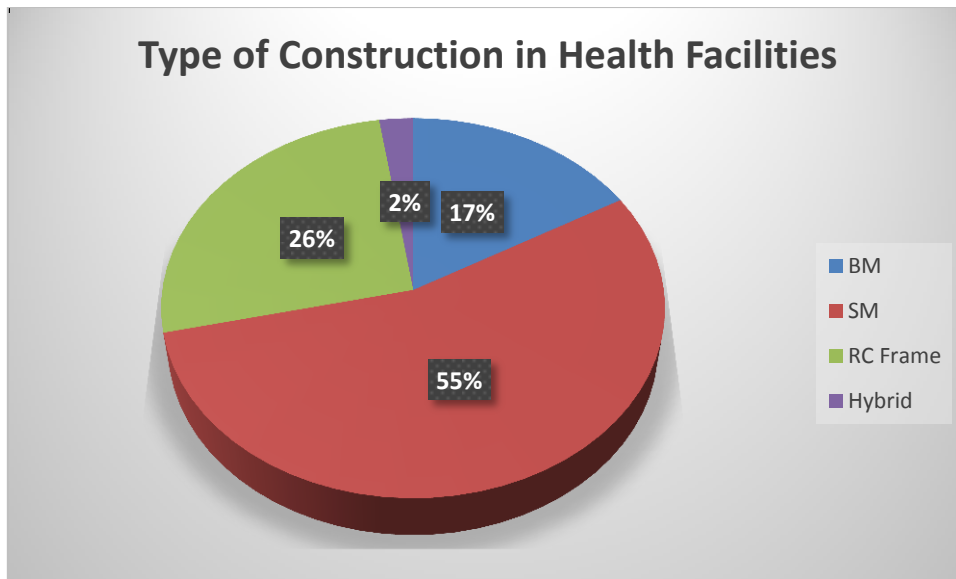

Figure 54: Building Typology of Health Institutions

Most of the hospitals were old buildings constructed at least 20-30 years back. 55% buildings were stone masonry followed by 26% RC frame and 17% brick masonry buildings. Surprisingly hospitals and health centres constructed 40-50 years back (before 1970) were not found highly vulnerable (figure 55). It is due to old traditional building construction practice of making stone masonry buildings.

A large proportion of hospitals constructed within last 30 years were found medium to high vulnerable for earthquake during RVS. The above component only defines the structural vulnerability. Non-structural hazard is not included here which poses a major challenge for the functioning of hospitals during emergency situations. Non-structural hazard mainly consist in case of hospitals include exterior falling hazard such as cladding, air conditioner units, plastic water tanks and interior falling hazard like unanchored costly and heavy medical equipment. These heavy medical equipment are usually supported on rollers hence more susceptible to damage during earthquake shaking if not properly anchored. Generally medicines stored in racks were found without any kind of support system. Horizontal strap can be provided to prevent the falling of medicines from the racks.

Structural safety of the hospital alone will not suffice. Functionality of the hospital also depend upon the functioning of other systems such water supply and electricity. Dependency of different systems on each other called as systemic vulnerability. For emergency, power back up and water storage facility should be available till the time permanent water and electricity supply can be restored.

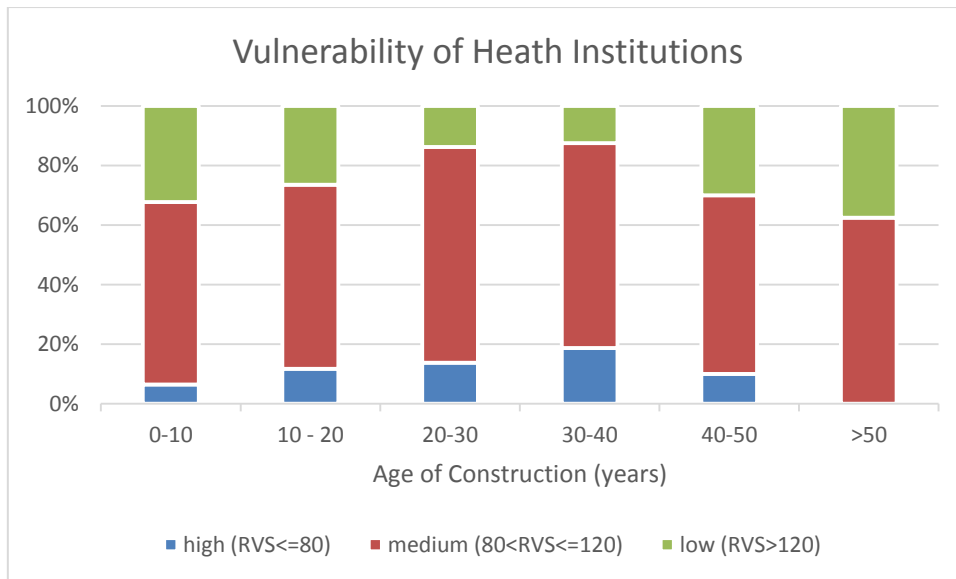

Figure 55: Vulnerability Status of Health Institutions under different age of construction

7.8.3 Government Buildings:

Government offices are required to be assessed for their safety as they have to be operational at the time of any emergency for rescue operations. 131 government buildings were screened during RVS which include all those important government building required to be functional for the emergency operation after a disaster. These buildings include DC office, DC resident, HP PWD offices, HPSEB offices, HPIPH offices and tourism office in each district/ sub district. Inclusion of tourism office was an important step as Himachal Pradesh attracts a lot of tourists. It is required to be operational to give the details about tourist during evacuation and rescue. Figure 56 represents the distribution of government buildings surveyed during RVS.

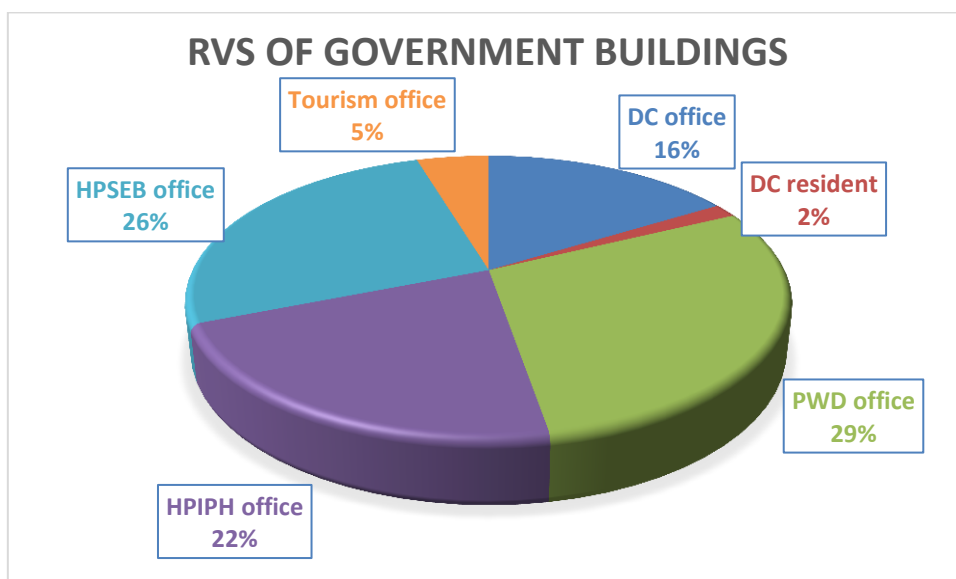

Figure 56: Government Buildings surveyed during RVS

After RVS it was found out that DC offices have low or medium vulnerability while PWD offices are more vulnerable (medium to high) in most of the places (figure 57). Electricity board offices and public health offices were also found to be more medium to high vulnerable hence they can suffer major damage during strong earthquake.

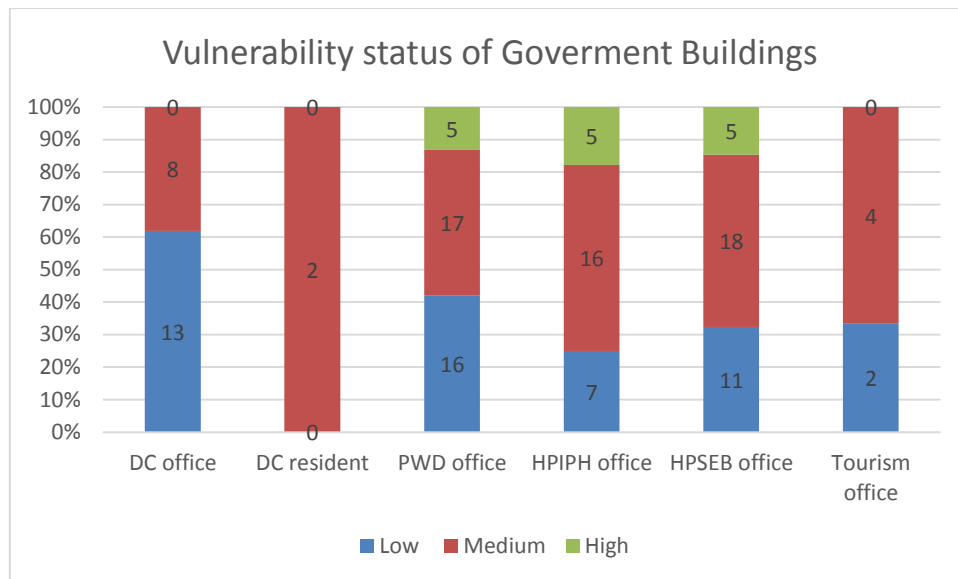

Figure 57: Vulnerability Status of Government Buildings

7.8.4 Cowsheds:

Cowshed were also surveyed during RVS of buildings in the state of Himachal Pradesh. Cowsheds are used for sheltering of cow, buffalo and other livestock animal. Mostly cowsheds are found as a two storied structure where ground story is used for keeping the animals and first floor is used as a store room for hay and other fodders (figure 58). Usually first floor in cowsheds is not of the same height as ground floor. Most predominant building typologies for cowsheds are brick masonry (34%) and rammed earth (34%) followed by stone masonry (18%) and hybrid buildings (14%) (Figure 59).

It was found that 83% buildings used mud mortar as a binding material in the construction of cowsheds while cement mortar was used in only 12% cowsheds. 5% cowsheds were built without using any mortar (figure 60). This clearly depicts the high vulnerability of cowshed in the absence of a good binding material for masonry buildings.



Figure 58: Cowsheds made of unburnt brick/mud wall and slate roof

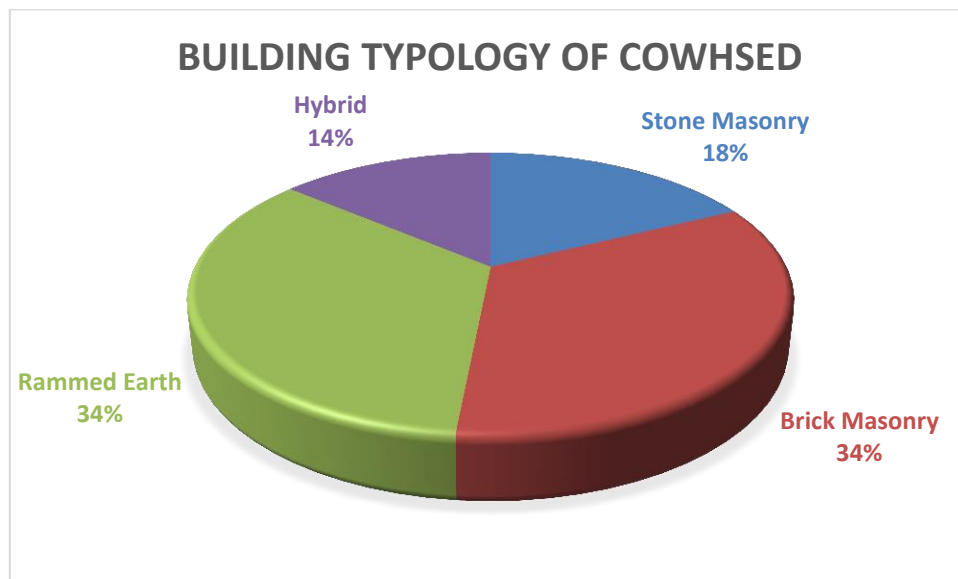

Figure 59: Building Typology of Cowshed

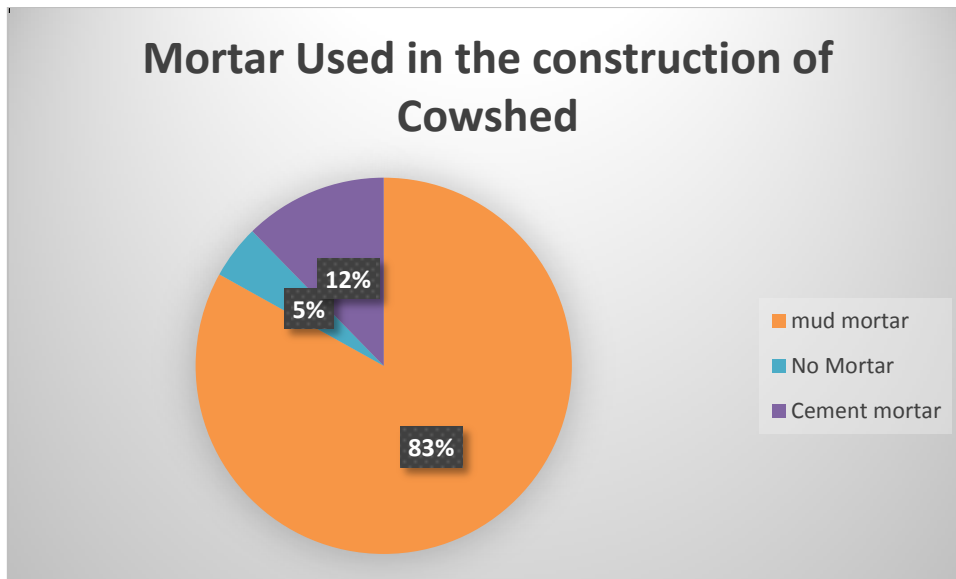

Figure 60: Mortar used in the Construction of Cowsheds

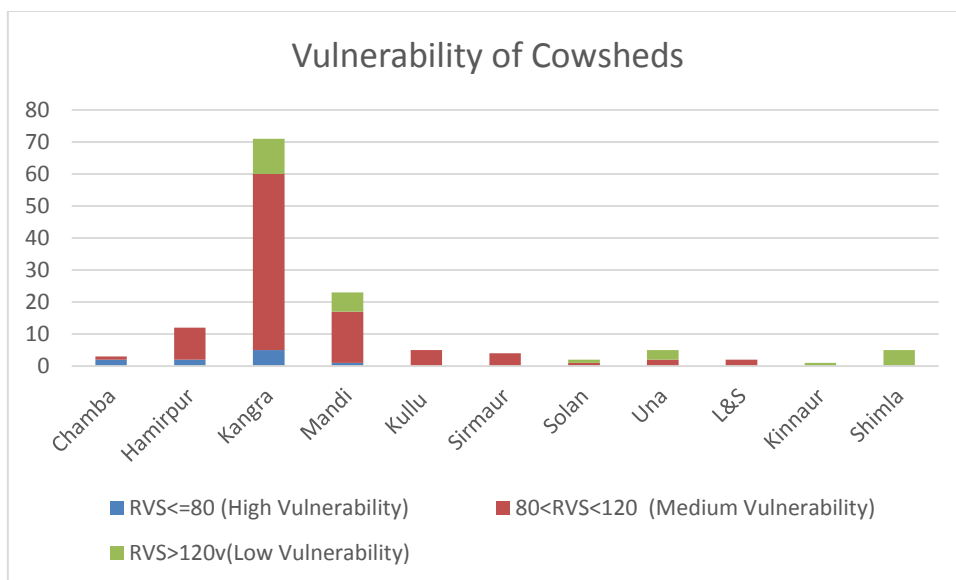

Figure 61: Vulnerability of Cowsheds in Different Districts of H.P.

Fig 61 describe the degree of vulnerability of cowsheds in different districts of the state. Total 130 cowsheds were surveyed during RVS in 12 districts of the state. Cowsheds were found highly vulnerable in Chamba, Hamirpur and Kangra where cowsheds were mostly constructed using rammed earth and heavy stone/ wood. Slates were used as roofing material. Cowsheds built in Shimla were found of good quality.

7.9 Building Vulnerability Distribution at District Level in the State:

After calculating the performance score of all the surveyed buildings, normal distribution curves are generated for different typology of buildings. For brick masonry buildings the score ranges from 40 to 220 for 4141 buildings. For reinforced concrete buildings the score ranges from 50 to 160 for 1466 buildings. For hybrid buildings the score ranges from 60 to 140 for 1180 buildings. For stone masonry buildings the score

ranges from 30 to 170 for 1042 buildings. For rammed earth buildings the score ranges from 50 to 150 for 509 buildings. The state Himachal Pradesh contains 12 districts namely, Bilaspur, Chamba, Hamirpur, Kangra, Kullu, Mandi, Simla, Sirmur, Solan, Una, Lahul Spitti, and Kinnaur. From the above data, RVS score is calculated for each district in Himachal Pradesh and plotted in QGIS. Normal distribution curves are generated based on available RVS scores. The normal distribution curves for total buildings as per district wise are shown in figure 62-67. From the above studies, it is clearly shown that all typology of buildings are available in the district of Kangra.

A wider normal distribution curve of RVS score of building typology for a district demonstrate the presence of huge variation in the vulnerability of building. A narrow normal distribution curve represent that most of the buildings were constructed on a similar kind of construction practice and quality either good or bad and they will be subjected to almost nearly equal extent of damage during earthquake.

7.9.1 Brick Masonry buildings:

From the study, the number of brick masonry buildings is more in Bilaspur, Kangra, Una, Sirmur, Mandi and Hamirpur. The number of buildings present in these districts is more than 100. Few buildings are present in the rest of districts. The mean of RVS score of all districts ranges from 100-130 (figure 62). From the observation, brick masonry buildings are evenly distributed throughout the state.

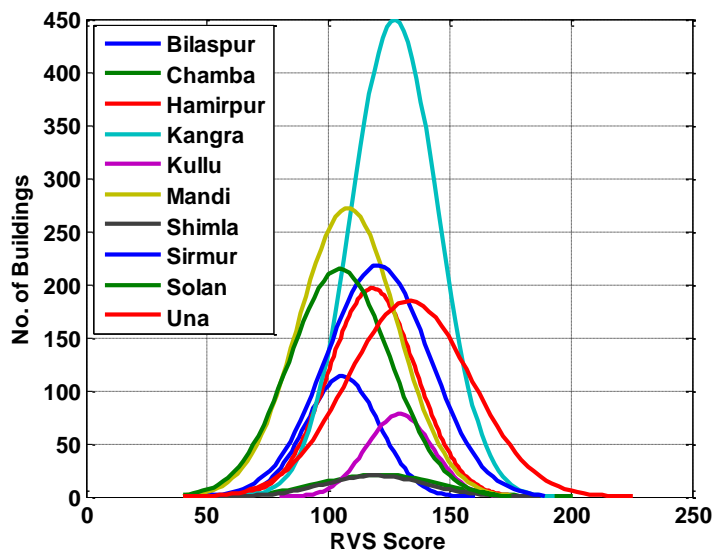

Figure 62: Normal distribution curve for brick masonry buildings through RVS

7.9.2 Stone Masonry buildings:

From the study, the number of stone masonry buildings is more in Kangra district. The normal distribution curves are wider for almost every district. Since the state is located in hilly terrain, stone masonry buildings are constructed in every district. The mean of RVS score of all districts ranges from 90-115 (figure 63).

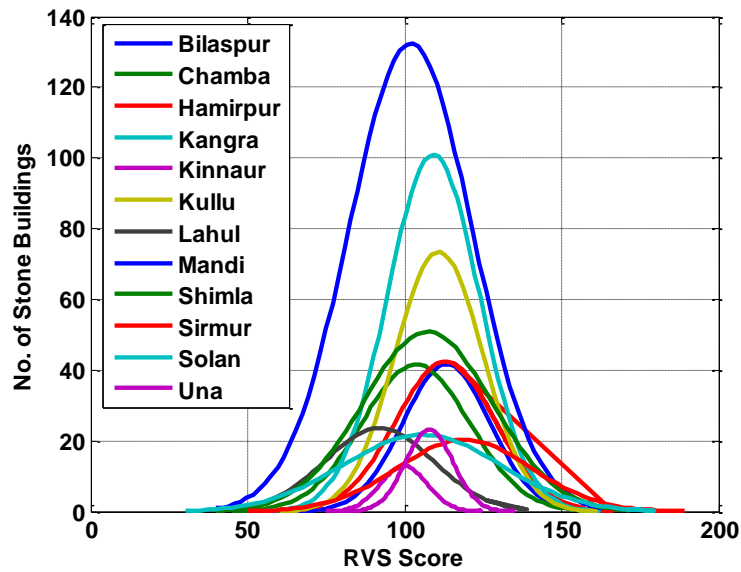

Figure 63: Normal distribution curve for Stone Masonry buildings through RVS

7.9.3 Rammed earth buildings:

From the study, the number of rammed earth buildings is more in Kangra district. The normal distribution curves are wider for almost every district. Except Kangra district, the number of rammed earth buildings is few in other districts. The mean of RVS score of all districts ranges from 95-115 (figure 64).

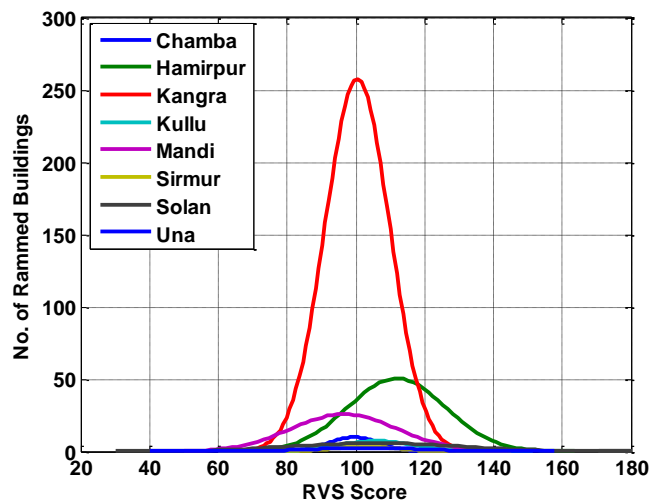

Figure 64: Normal distribution curve for Rammed earth buildings through RVS

7.9.4 Hybrid buildings:

From the study, the number of hybrid buildings is more in Kangra district. Since the normal distribution curve is narrow for Kangra district, the RVS score ranges from 60 to 140 (figure 65). Except Kangra, and Una, the distribution curve is wider for rest of districts. The mean of RVS score of all districts ranges from 100-110.

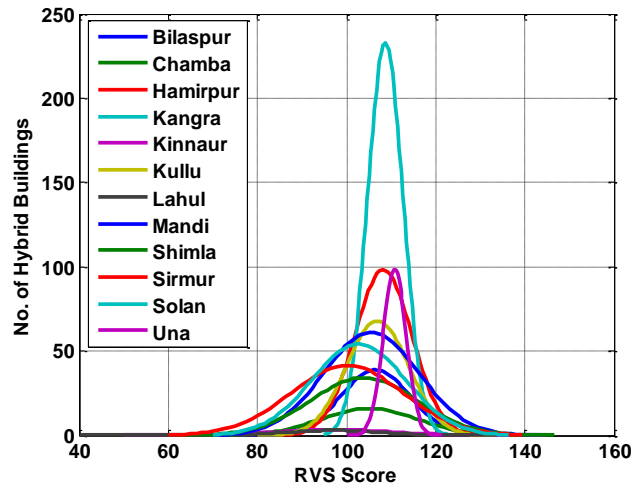

Figure 65: Normal distribution curve for Hybrid buildings through RVS

7.9.5 RC Frame Buildings:

From the study, the number of RC frame buildings is more in Bilaspur district. Normal distribution curve is wider for almost all the district and RVS score for all districts ranges from 60-155 (figure 66). Most of the RC frame buildings are present in Bilaspur, Kullu, Kangra, Shimla and Mandi.

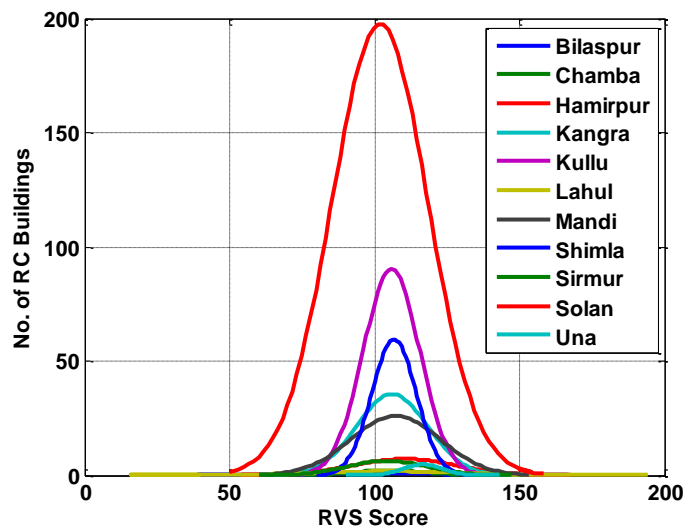

Figure 66: Normal distribution curve for RC buildings through RVS

Fig. 67 shows the variation of RVS score of five predominant building typology of Himachal Pradesh. Largest variation in RVS score was observed for brick masonry building while the smallest variation of RVS score was observed in hybrid buildings.

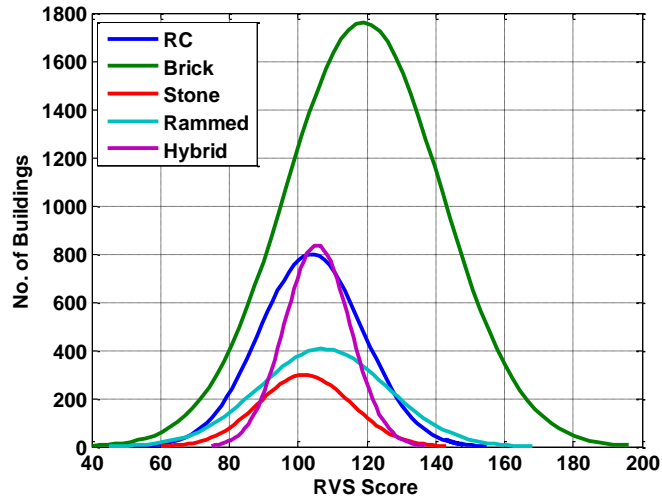

Figure 67: Normal Distribution Curve for All Building Typologies

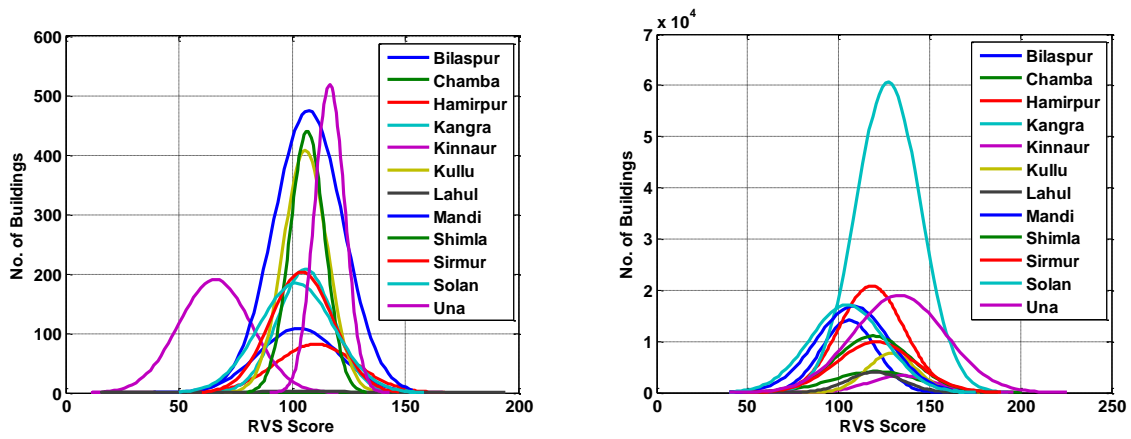

Figure 68: Normal distribution curve for RC buildings & Brick Masonry Buildings

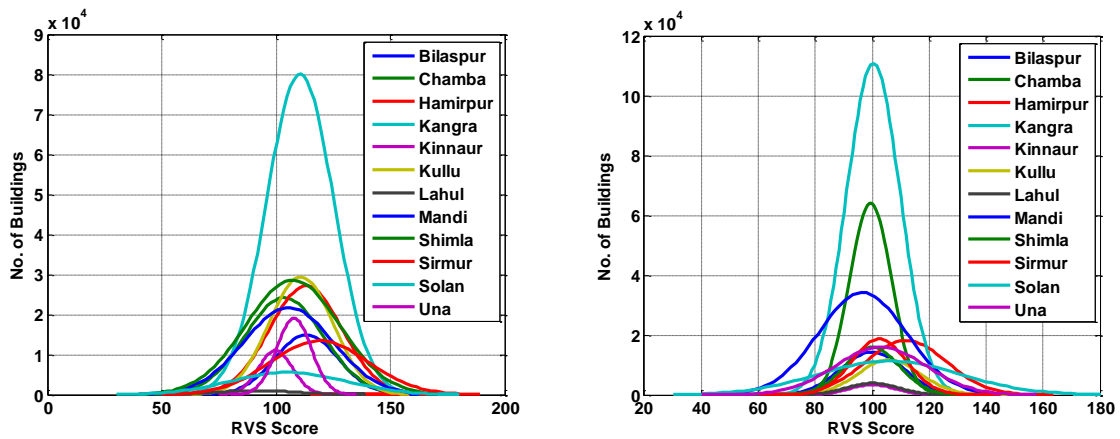

Figure 69: Normal distribution curve for Stone Masonry and Rammed Earth Buildings

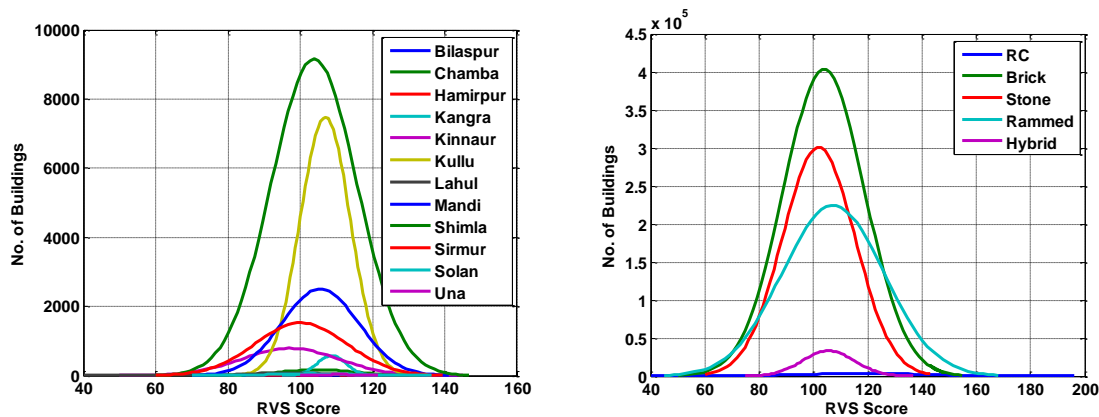

Figure 70: Normal distribution curve for Hybrid Buildings and Typology wise

Normal distribution curve shown in the figure 68 to 70 represents the variation of RVS score for total building stock of five predominant typology in all 12 districts of Himachal Pradesh. Extrapolation is done to represent the variation of vulnerability of buildings in the state.

8. PRELIMINARY VULNERABILITY ANALYSIS

Preliminary vulnerability analysis (PVA) requires the analysis of the building data collected through rapid visual screenings of the building. Preliminary assessment techniques are employed to analyze the building performance when a more reliable assessment is required. This requires detailed information regarding the structural components, material properties and site conditions. Preliminary vulnerability analysis (PVA) was carried out over 47 buildings selected on the basis of RVS score of buildings. After RVS scoring of 20,000 buildings, buildings were selected from low, medium and high performance score. A building with high performance score is expected to perform better at the time of earthquake in comparison to the buildings with low performance score and having more building vulnerability features. Apart from RVS score, they were also selected in such a way so that it represents all type of building typology present in the state of Himachal Pradesh.

Detailed information was collected about structural details and material properties. Buildings drawings were obtained if available. In case of non-availability of drawings, building plan was drawn and other information was obtained through the owner of the building. Non-destructive testing was carried out in almost all the buildings to get the material properties. Different NDT test such as rebound hammer method, ultra-sonic pulse velocity method and rebar locator were carried out on different type of buildings (RC Frame, Brick and Stone Masonry, Rammed Earth and Hybrid Buildings).

8.1 Methodology:

Preliminary vulnerability analysis is the second step of the building vulnerability process. It is required to assess the selected building sample of varying vulnerability in detail. 47 buildings were identified in 6 different districts (Shimla, Mandi, Sirmaur, Hamirpur, Kangra and Una) in the state of Himachal Pradesh. A team of 8 experts visited these sites to conduct this level of assessment.

This phase involves the following tasks:

- Collection of drawings and redraw (if possible) in AutoCAD,
- Identification of the sizes of all columns and beams,
- Load calculations,
- Configuration related checks and strength related checks.

Phase-II can broadly be classified into two categories, (a) configuration-related and (b) strength related checks. The first tier involves a quick assessment of the earthquake resistance of the building and its potential deficiencies, with the objective to screen out the significantly vulnerable structures for the second tier detailed analysis and evaluation. The first tier evaluation typically consists of assessing the configurationally induced deficiencies known for unsatisfactory performance along with a few global level strength checks, whereas the next level of evaluation consists of proper force and displacement analysis to assess structural performance at both global and/or component level.

8.1.1 Configuration related checks:

Although a building with an irregular configuration may be designed to meet all code requirements, irregular buildings generally do not perform as well as regular buildings in an earthquake. Typical building configuration deficiencies include an irregular geometry, a weakness in a given story, a concentration of mass, or a discontinuity in the lateral force resisting system. Vertical irregularities are defined in terms of strength, stiffness, geometry and mass. Horizontal irregularities involve the horizontal distribution of lateral forces to the resisting frames or shear walls.

Load Path:

Inertial forces, induced as a result of the seismic force effects from any horizontal direction, are transferred from the mass to the foundation through the load path. If there is a discontinuity in the load path, the building is unable to resist seismic forces regardless of the strength of the existing elements.

Weak Story:

The story strength is the total strength of all the lateral force-resisting elements in a given story for the direction under consideration. Weak stories are usually found where vertical discontinuities exist, or where member size or reinforcement has been reduced. The result of a weak story is a concentration of inelastic activity that may result in the partial or total collapse of the story.

Soft Story:

Soft story condition commonly occurs in buildings with open fronts at ground floor or with particularly tall first stories. Soft stories usually are revealed by an abrupt change in interstory drift.

Effective Mass:

Mass irregularities can be detected by comparison of the story weights. The effective mass consists of the dead load of the structure tributary to each level, plus the actual weights of partitions and permanent equipment at each floor. Mass irregularities affect the dynamic response of the structure, and may lead to unexpected higher mode effects and concentrations of demand.

Torsion:

Whenever there is significant torsion in a building, the concern is for additional seismic demands and lateral drifts imposed on the vertical elements by rotation of the diaphragm. Buildings can be designed to meet code forces including torsion, but buildings with severe torsion are less likely to perform well in earthquakes.

8.1.2 Strength Related Checks:

The seismic evaluation documents specify some global level checks to quickly identify the major deficiencies. At the global level, buildings are mainly checked for shear stress and axial stress.

8.2 Non-destructive Testing (NDT):

In non-destructive method, material of the building is tested without causing any damage to the structure. There are various NDT methods are available for different kind of structure. These methods have their own limitations in terms of their applicability and degree of accuracy. They should be applied suitably for each structure sometimes in a combination to cross check the results obtained or to get the more accurate results. Three NDT methods were implied on selected 47 structure of five predominant building typology. These methods vary from simplest one of rebound hammer test to the more sophisticate method like ultrasonic pulse velocity method. It is preferable to use rebound hammer test in combination with ultrasonic pulse velocity method to alleviate the error arising out of influence of material, mix and environmental parameters on the respective measurements. These NDT methods are described below in detail with their procedure and limitations.

8.2.1 Rebound Hammer Test:

Rebound hammer method is used to find out the compressive strength of the concrete used. IS 13311 (Part 2): 1992 describes the specifications of the instrument and procedure to conduct the test. Rebound hammer consists of a spring controlled mass that slides on a plunger within a tubular housing. It is calibrated the rebound hammer against a testing anvil before commencement of a test to ensure the reliable result. Rebound hammer test can be used to differentiate between questionable and acceptable quality of concrete.

Objective: Rebound hammer test is used to measure the following property of the material:

- Compressive strength of the concrete by using the relationship between rebound index and compressive strength
- Uniformity of the concrete
- Quality of concrete
- Comparison of the quality of concrete between two element

Concept: The rebound of an elastic mass depends on the hardness of the surface against which its mass strikes. When the plunger of the rebound hammer is pressed against the surface of the concrete, the spring-controlled mass rebounds and the extent of such a rebound depends upon the surface hardness of the concrete. The surface hardness and therefore the rebound is taken to be related to the compressive strength of the concrete. The rebound value is read from a graduated scale and is designated as the rebound number or rebound index.

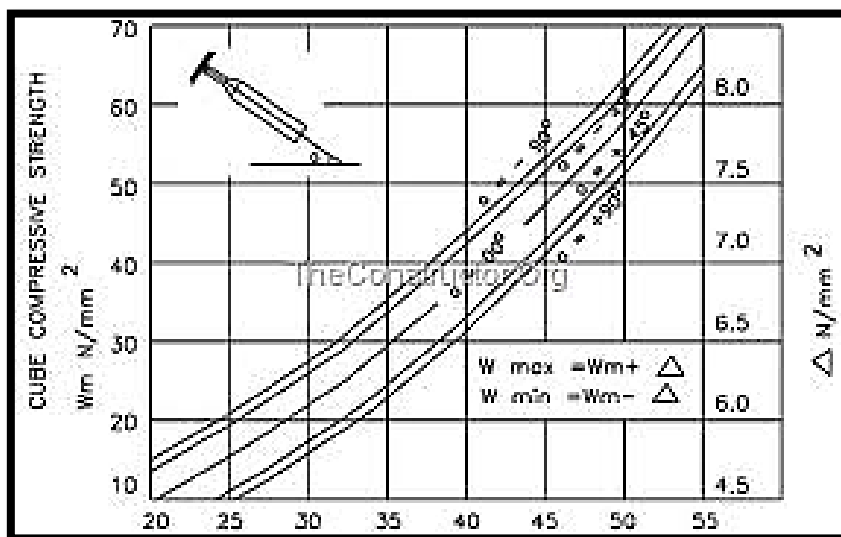

Figure 71: Chart of correlation between rebound number and cube compressive strength (Source: www.construction.org)

Procedure: A smooth, dry and clean surface is selected to conduct this test. If any loose adhering materials are present, they should be removed as improper compaction on the rough surface can result into unreliable results. The point of impact should be atleast 20 mm away from the any edge or corner. For an accurate measurement, rebound hammer should be perpendicular to the surface of the concrete member. Rebound hammer test is conducted around all the possible point on all the accessible surfaces. It is recommended to take 6 reading around each observation point and their average reading is taken a rebound hammer test.

Interpretation of the Result: Compressive strength can be read directly from the graph provided by the manufacturer on the body of the instrument (figure 71). The rebound reading on the indicator scale has been calibrated by the manufacturer of the rebound hammer for horizontal impact. When used in any other position, appropriate correction as given by the manufacturer is to be taken into account. A higher rebound number indicates the good strength of the concrete.

Limitation: The rebound hammer method provide a convenient and rapid method to evaluate the compressive strength of the concrete by establishing a curve between rebound indices and compressive strength of the concrete. Rebound indices are representative of concrete strength up to a limited depth of concrete only as internal micro cracks cannot be indicated by this test. Probable accuracy of concrete strength in a structure is $\pm 25\%$.

8.2.2 Ultrasonic Pulse Velocity Method:

This test is done to assess the quality of concrete by ultrasonic pulse velocity method as per IS: 13311 (Part 1) – 1992. This test is considered to be more accurate method in comparison to rebound hammer test.

Objective: The ultrasonic pulse velocity method could be used to establish:

- Homogeneity of concrete
- Presence of cracks, voids and other imperfections
- Changes in the structure of the concrete which can occur with the time
- The quality of concrete in relation to the standard requirements
- The quality of one element of concrete in relation to another
- The value of dynamic elastic modulus of concrete

Concept: When the pulse is induced into the concrete from a transducer, it undergoes multiple reflections at the boundaries of the different material phases within the concrete. A complex system of stress waves is developed which includes longitudinal (compressional), shear (transverse) and surface (rayleigh) waves. The receiving transducer detects the onset of the longitudinal waves, which is the fastest.

Procedure: The apparatus of ultrasonic pulse velocity measurements consist of four devices i.e. electronic pulse generator, one pair of transducers, amplifier and electronic time device. Transducer is held in contact with concrete surface and ultrasonic pulse is generated. Pulse of vibration is converted into an electric signal by the second transducers which is held in contact with other surface of the structural member and an electronic timing circuit enables to the transit time of the pulse to be measured. Three methods of measurements are used i.e. direct, semi-direct and indirect method (figure 72).

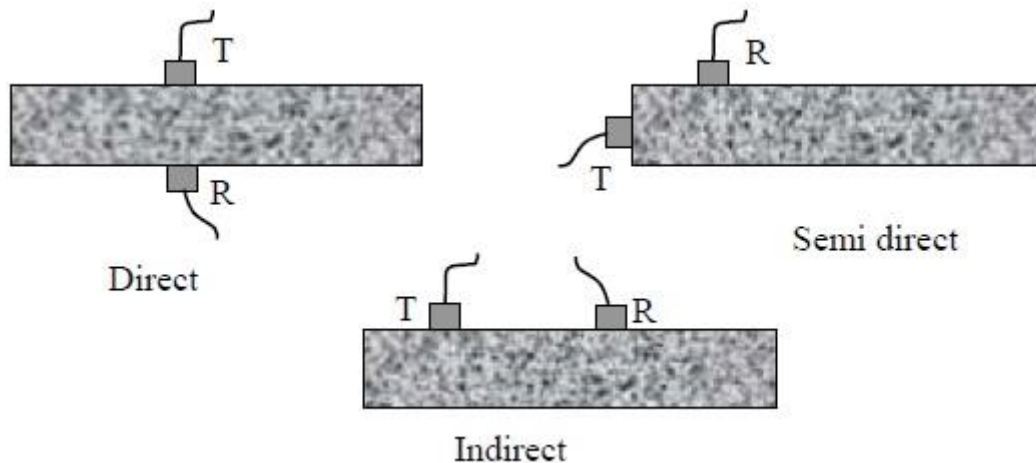

Figure 72: Various Transmission modes for Ultrasonic Pulse Velocity Method (Source: CPWD 2007)

The direct method is the most reliable but it requires access to the member from both the sides. But in many cases, it is not possible to access the two opposite faces of the member. In such situations, a second transducer is also placed on the same side of the member and it is called as indirect method. Adequate coupling between the concrete and face of each transducer is required to receive the signal properly. Typical couplants are like petroleum jelly, grease and liquid soap etc. A minimum path length of 150 mm is required for direct method.

Interpretation of Result: Comparatively higher velocities are obtained for good quality (density, homogeneity and uniformity) of concrete (Table 21). If there is any void, crack or flaw inside the concrete which comes in the way of transmission of pulses, pulse strength is attenuated and it takes a longer path to travel through discontinuity. Consequently lower velocities are obtained. The actual pulse velocity obtained depends upon the materials and mix proportion of the concrete. Density and modulus of elasticity of aggregate also affect the pulse velocity.

Table 21: Velocity Criterion For Concrete Quality Grading	
Pulse Velocity (Km/ Second)	Concrete Quality (Grading)
Above 4.5	Excellent
3.5 to 4.5	Good
3.0 to 3.5	Medium
Below 3.0	Doubtful

Source: IS 13311 (Part1):1992

Limitation: An overall estimation of concrete strength can be obtained from this test but it is difficult to point out the exact location of the defect by UPV test. Results obtained from UPV test depend on many parameters apart such as workmanship and curing of concrete apart from the concrete mix.

8.2.3 Rebar Locator Test:

Rebar locator test is conducted on the structural members made of concrete. It is useful in finding out the following properties of the concrete members:

1. Detection of reinforcing bar and meshes
2. Measurement of the cover depth of reinforcement
3. Determination of reinforcing bars and their diameter

Orientation of the reinforcing bar can be identified when the device is aligned parallel to the bar line. To locate the horizontal bars perpendicular to the vertical bars, device is moved up and down. To locate lines of vertical reinforcing bars, structural member is scanned horizontally from side to side.

8.3 Preliminary Vulnerability Assessment of buildings:

47 Buildings were thoroughly investigated during the second phase of vulnerability assessment i.e. Preliminary Vulnerability Assessment (PVA). Under this phase of building assessment, building drawings were collected or drawn if not available. Material properties were estimated by conducting the non-destructive testing on the selected structures. Buildings were chosen from wide range of vulnerability (low to high). Details of beam column joints, beam, columns, location and details of staircase were also noted down carefully which will be required to create the model of the building for detailed building vulnerability assessment.

Different building types (Type of construction and use of building) were covered for NDT testing to represent all major building typology. Reinforced concrete frame, brick masonry, stone masonry, rammed earth and hybrid construction were selected which represents different utility of buildings like residential, educational, commercial, govt. offices and cowsheds.

Team	District Visited	Number of Buildings subjected to NDT testing
Team 1	Shimla	13
	Sirmaur	5
	Mandi	4
Team 2	Una	5
	Hamirpur	8
	Kangra	12

Source: TARU Analysis 2013

District	Type of Construction					Use of Buildings				
	RC	BM	SM	RE	H	Res.	Edu.	Com.	Govt.	CS
Shimla	3	6	-	1	1	8	1	1	-	-
Sirmaur	3	2	-	-	1	4	1	1	-	-
Mandi	3	2	-	-	-	5	-	-	-	-

Una	2	3	-	-	-	3	2	-	-	-
Hamirpur	5	3	-	-	-	5	-	2	-	-
Kangra	2	5	1	2	2	6	2	1	2	1
<i>Source: TARU Analysis 2013</i>										

Type of Construction:

RC: Reinforced Concrete Frame structure, BM: Brick Masonry, SM: Stone Masonry, RE: Rammed Earth, H: Hybrid Structure

Use of Building:

Res: Residential, Edu: Educational, Com: Commercial, Govt: Government Offices, CS: Cowshed

Rebound hammer test was used mostly in all the structures (Fig. 73). Detailing of reinforcement in the column of RC frame structures can be judged by going at the top of the roof. Vertical projected steel bars can be found in most of the RC frame structures. Whenever it was not possible to judge, rebar locator was used to find the concrete cover, diameter and spacing of reinforcement (Fig. 76). Spacing between can also be judged using rebar locator.



Figure 73: Rebound Hammer Test (Hamirpur, 15th December 2013)

Ultrasonic pulse velocity method was used to check the strength and homogeneity of the concrete (Fig. 74 & 75). This technique is a more accurate method than rebound hammer test. In rebound hammer test, 15 to 20% error can occur.



Figure 74: Ultrasonic Pulse Velocity Method (Kangra, 17th December 2013)



Figure 75: Preparation of instrument before Ultrasonic Pulse Velocity Method (Kangra, 17th December 2013)



Figure 76: Rebar Locator Test (Kangra, 17th December 2013)

Table 24 provides the list of buildings surveyed during PVA with their details such as latitude/ longitude, Address, RVS score, type of construction, NDT test conducted on the buildings and their corresponding material characteristic (Concrete and Brick strength).

Table 24: Building Details collected during Preliminary Vulnerability Assessment

Sr. No	District	Building Type	Storey	LAT	LONG	Use of Building	RVS	Zone	YOC	Test	Concrete (N/mm ²)	Brick (N/mm ²)
1	Hamirpur	RC	2	31°40'48.00" N	76°31'28.38" E	Commercial	12/5	I/V	20/05	Rebound Hammer	12.6	9
2		RC	3	31°41'13.68" N	76°30'42.96" E	Residential	83	I/V	19/86	Rebound Hammer	12.2	12.13
3		RC	3	31°41'11.94" N	76°31'12.18" E	Residential	10/3	I/V		Rebound Hammer	18.8	11
4		BM	2 + Steel	31°41'04.80" N	76°31'11.76" E	Residential	11/3	I/V		Rebound Hammer	20	19
5		BM	2	31°41'12.54" N	76°31'01.98" E	Residential	11/0	I/V	19/80	Rebound Hammer	19.5	13.5
6		BM	1	31°41'05.04" N	76°31'26.70" E	Residential	83	I/V	19/70	Rebound Hammer		10
7		RC +Stone	1	NA		Ware House	11/8	I/V	19/70	Rebound Hammer	15	16
8		RC	2	NA		Residential	11/5	I/V	20/00	Rebound Hammer	12.25	10

Sr. No	District	Building Type	Storey	LAT	LONG	Use of Building	RVS	Zone	YOC	Test	Concrete (N/mm ²)	Brick (N/mm ²)
9	Kangra	BM	1	32°13'52.44" N	76°10'02.94" E	Residential	85	V	20	Rebound Hammer	8	9.25
10		Hybrid	2	32°13'52.44" N	76°10'02.94" E	Educational	95	V		Rebound Hammer	14	14
11		BM	1	32°13'42.42" N	76°10'10.62" E	Residential	83	V	20	Rebound Hammer	14.5	15
12		BM	2	32°13'32.58" N	76°09'59.88" E	Residential	83	V	20	Rebound Hammer	14	8.65
13		BM	1	32°11'38.52" N	76°13'55.14" E	Residential	105	V	19	Rebound Hammer	13.5	10.3
14		BM	1	32°11'15.18" N	76°13'23.52" E	Residential	85	V	19	Rebound Hammer	14.8	10
15		RC	3	32°06'45.54" N	76°16'48.24" E	Commercial	96	V	20	Rebound Hammer, Ultrasonic, Rebar Locator	12.9	8
16		RC	3	32°06'18.90" N	76°16'19.74" E	Educational	70	V	19	Rebound Hammer, Ultrasonic, Rebar Locator	15	9
17		Traditional	2	32°07'11.94" N	76°17'08.52" E	Residential	95	V	19	Rebound Hammer	NA	
18		Traditional	2	32°07'11.94" N	76°17'08.52" E	Cowshed	85	V	19	Rebound Hammer	NA	
19	Stone M	2	NA		Government	110	V	19	Rebound Hammer	NA		
20	Wooden+Stone	1	NA		Government	115	V	19	Rebound Hammer	NA		
21	Una	BM	1	31°24'22.14" N	76°20'32.16" E	Residential	105	V	19	Rebound Hammer	14.75	9.5
22		RC	2	31°24'42.18" N	76°20'12.30" E	Educational	100	V	20	Rebound Hammer, Ultrasonic, Rebar Locator	16	11.25
23		BM	2	31°24'12.42" N	76°20'13.14" E	Educational	123	V	20	Rebound Hammer	18.6	11.2
24		BM	2	31°27'51.36" N	76°16'04.80" E	Residential	113	V	19	Rebound Hammer	13.75	7.8
25		RC	1	31°28'39.42" N	76°16'28.80" E	Residential	100	V	20	Rebound Hammer	9.3	9
26	Mandi	BM	3	31°032'31" N	76°054'01" E	Residential	52	V				
27		BM	1	31°032'31" N	76°054'03" E	Residential	85	V				
28		RC	3	31°032'02" N	76°054'13" E	Resi+Comm	61	V		Rebound Hammer	17	9.5
29		RC	4	31°032'00" N	76°053'21" E	Residential	55	V		Rebound Hammer	18.66	8.6
30		RC	2	31°032'04" N	76°053'23" E	Residential	95	V		Rebound Hammer	23	NA
31	Shimla	RC	3	31°09'22" N	77°12'44" E	Commercial	105	V		Rebound Hammer	16.43	NA
32		BM	2	31°06'10" N	77°10'33" E	Residential	85	V				
33		Hybrid	2+truss	31°06'10" N	77°10'28" E	Residential	105	V				
34		BM	4	31°06'11" N	77°10'21" E	Residential	35	V				

Sr. No	District	Building Type	Storey	LAT	LONG	Use of Building	RVS	Zone	YOC	Test	Concrete (N/mm ²)	Brick (N/mm ²)
35		BM	1+truss	31° 06' 12" N	77° 10' 04" E	Residential	105	I V				
36		RC	5	31° 05' 46" N	77° 10' 36" E	Guest house	75	I V		Rebound Hammer	21.64	9.7
37		RC	1+truss	31° 05' 39" N	77° 10' 36" E	Educational	135	I V		Rebound Hammer	16	NA
38		BM	2	31° 05' 03" N	77° 10' 08" E	Resi+Comm	105	I V				
39		Rammed earth	Truss	31° 52' 00" N	77° 10' 08" E	Residential	120	I V	1990			
40		RC	2	31° 04' 58" N	77° 10' 10" E	Resi+Comm	115	I V		Rebound Hammer	18	6
41		BM	2+truss	31° 04' 59" N	77° 10' 13" E	Resi+Comm	82	I V				
42		RC	3	30° 33' 29" N	77° 17' 41" E	Resi+Comm	86	I V		Rebound Hammer	22	NA
43		BM	3	30° 33' 28" N	77° 17' 22" E	Residential	125	I V				
44	Sirmaur	RC	5+roof	30° 33' 52" N	77° 17' 49" E	Hospital	90	I V		Rebound Hammer	26	NA
45		BM	2	30° 33' 36" N	77° 17' 24" E	Educational	105	I V				
46		Hybrid	4	30° 33' 44" N	77° 17' 19" E	Residential	120	I V	1994			
47		RC	3	30° 34' 1" N	77° 17' 51" E	Resi+Comm	106	I V		Rebound Hammer	19	NA

9. DETAILED VULNERABILITY ANALYSIS:

The in-depth evaluation through sophisticated structural analysis falls within the third category of vulnerability assessment which is called as "Detailed Vulnerability Analysis (DVA)". In this final step of building vulnerability analysis, modelling was done for 26 buildings. These includes 7 RC frame structures, 8 brick masonry, 2, stone masonry, 7 rammed earth and 2 hybrid buildings. Finite element method (FEM) and applied element method (AEM) both were used to study the behaviour of buildings and compare the results. Both methods have their own limitation in terms of doing the analysis. Push over analysis was done to study the inelastic behaviour of structures. Lateral load was applied at different iterations to study the full collapse behaviour of the different structures. Curves were drawn between base shear and drift storey to analyse these results. Finally fragility curve were developed for five predominant building typology i.e. RC frame, stone masonry, brick masonry, rammed Earth and hybrid structures. A correlation was established to link the RVS score with peak ground acceleration (PGA) values so that level of damage can be assessed for each building by conducting the RVS itself for the state of Himachal Pradesh.

These fragility curves were used to determine the number of buildings damaged due to earthquake of different return period (100 yrs, 200yrs, 475yrs and 2475 yrs). As PGA

values vary spatially and higher value are expected for higher return period of earthquakes, number and level of damage for all the building stock in the state of Himachal Pradesh was obtained for different intensity of earthquake. Economic losses due to building damage were also computed.

9.1 Methodology for numerical modelling of buildings:

The numerical techniques can be categorized in two ways. The first case assumes that the material as continuum like finite element method (FEM). The other category assumes that the material as discrete model like rigid body spring model (RBSM), extended distinct element method (EDEM) and applied element method (AEM) (Hatem, 1998).

The RBSM performs only in small deformation range. EDEM overcomes all the difficulties in FEM, but the accuracy is less than FEM in small deformation range. Till now there is no method among all the available numerical techniques, in which the behaviour of the structure from zero loading to total complete collapse can be calculated with high accuracy. Figure 77 represents the overview of numerical techniques.

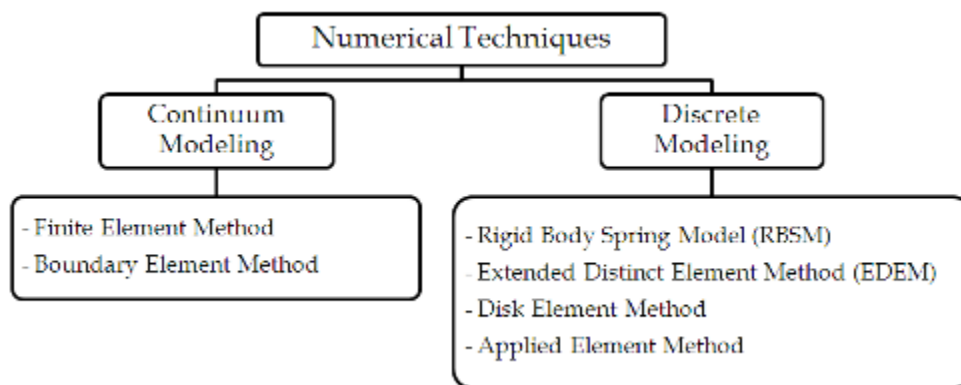

Figure 77: Overview of numerical techniques

9.1.1 Applied Element Method (AEM):

Finite Element Method could not be able to simulate the complete collapse behaviour of structure, whereas, EDEM method follows till structural collapse of the structure, but accuracy is lesser than FEM. The method which combines the advantages of both FEM and EDEM is AEM. This is the only method, which can be used for analysis from crack initiation, crack propagation to the complete collapse of the structure. Failure of reinforcement can also be found out from this method, which is important in estimating damage. In this project, assessment of damage plays a vital role. Pushover analysis is one of the methods to estimate capacity of structure. To assess damage of building, AEM method has chosen for further analysis.

Applied element method is a discrete method in which the elements are connected by pair of normal and shear springs which are distributed around the element edges. These springs represents the stresses and deformations of the studied element. The elements motion is rigid body motion and the internal deformations are taken by springs only.

The general stiffness matrix components corresponding to each degree of freedom are determined by assuming unit displacement and the forces are at the centroid of each element. The element stiffness matrix size is 6x6. The stiffness matrix components diagram is shown in figure 78. However, the global stiffness matrix is generated by summing up all the local stiffness matrices for each element.

The material model used in this analysis is Maekawa compression model (Tagel-Din Hatem, 1998). In this model, the tangent modulus is calculated according to the strain at the spring location. After peak stresses, spring stiffness is assumed as a minimum value to avoid having a singular matrix. The difference between spring stress and stress corresponding to strain at the spring location are redistributed in each increment in reverse direction. For concrete springs are subjected to tension, spring stiffness is assumed as the initial stiffness till it reaches crack point. After cracking, stiffness of the springs subjected to tension is assumed to be zero. For reinforcement, bi-linear stress strain relationship is assumed. After yield of reinforcement, steel spring stiffness is assumed as 0.01 of initial stiffness. After reaching 10% of strain, it is assumed that the reinforcement bar is cut. The force carried by the reinforcement bar is redistributed force to the corresponding elements in reverse direction. For cracking criteria (Hatem, 1998), principal stress based on failure criteria is adopted. The models for concrete, both in compression and tension and the reinforcement bi-linear model are shown in figure 79.

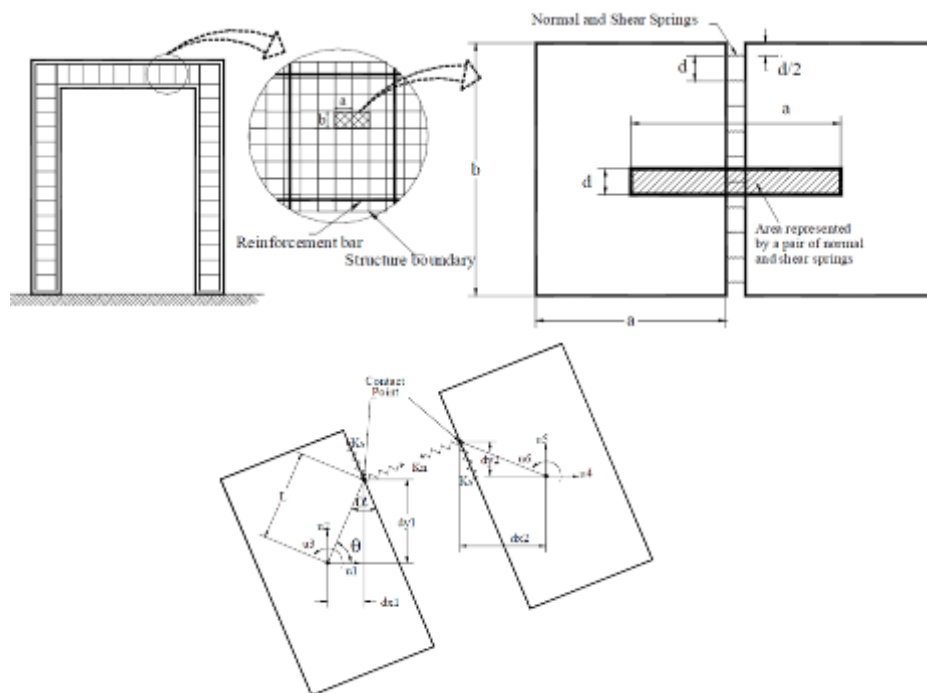
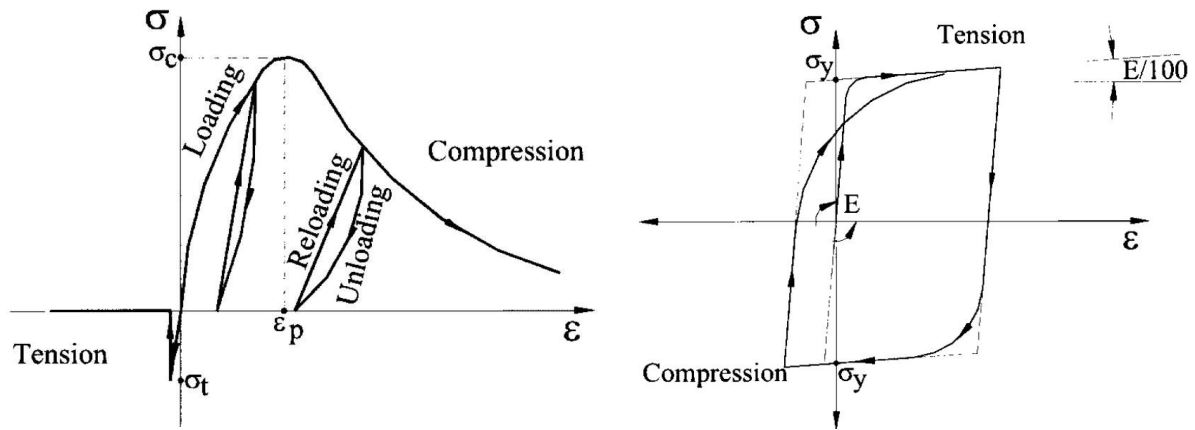

Figure 78: Modelling of structure in AEM and element shape, contact point and dof



To determine the principal stresses at each spring location, the following technique is used in this analysis. The shear and normal stress components at point A are determined from the normal and shear springs attached at the contact point location shown in figure 80. The secondary stress σ_2 from normal stresses and at point B and C can be calculated by using the equation given below:

$$\sigma_2 = \frac{x}{a} \sigma_B + \frac{a-x}{a} \sigma_c \quad (1)$$

The principal tension is calculated as:

$$\sigma_p = \frac{\sigma_1 + \sigma_2}{2} + \sqrt{\left(\frac{\sigma_1 - \sigma_2}{2}\right)^2 + \tau^2} \quad (2)$$

The value of principal stress (σ_p) is compared with the tension resistance of the studied material. When σ_p exceeds the critical value of tension resistance, the normal and shear spring forces are redistributed in the next increment by applying the normal and shear spring forces in the reverse direction. These redistributed forces are transferred to the element center as a force and moment, and then these redistributed forces are applied to the structure in the next increment. It is assuming that failure inside the element is represented by failure of attached springs (Hatem et al., 2000).

If the spring gets failed, then the force in the spring is redistributed. During this process, springs near the crack portion tend to fail easily. However, the main disadvantage of this technique is that the crack width cannot be calculated accurately.

In each increment, stresses and strains are calculated for reinforcement and concrete springs. In case of springs subjected to tension, the failure criterion is checked.

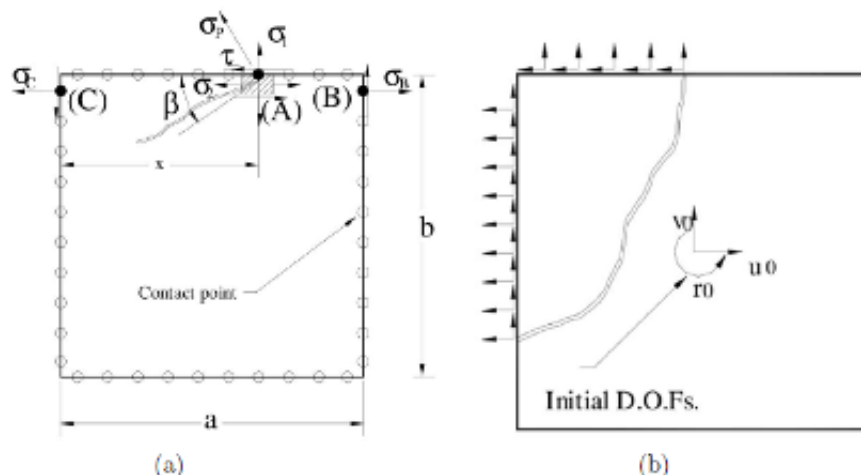

Figure 80: (a) Principal Stress determination and (b) Redistribution of spring forces at element edges

9.1.2 Finite Element Method (FEM):

Finite element method is one of the most important techniques used in the analysis. In this method, elements are connected by nodes where the degrees of freedom are defined. The displacement, stresses and strains inside the element are related to the nodal displacements. The accuracy of the element depends on the size of element. The analysis can be done in elastic and nonlinear materials, small and large deformations except collapse behaviour. At failure, the location of cracks should be defined before analysis which is not possible in collapse analysis. The problem becomes much more complicated when the crack occurs in 3D problems. In this analysis Takeda model is used. This model has been widely used in the nonlinear earthquake response analysis of RC structures. The description of model is as follows:

1. The cracking load P_{cr} , has not been exceeded in one direction. The load is reversed from the load P in the other direction. The load P is smaller than the yield load P_y . (Unloading follows a straight line from the position at load P to the point representing the cracking load in the other direction)
2. A load P_1 is reached in one direction on the primary curve such that P_1 is larger than P_{cr} but smaller the yield load P_y . The load is then reversed to $-P_2$ such that $P_2 < P_1$. (Unload parallel to loading curve for that half cycle)
3. A load P_1 is reached in one direction such that P_1 is larger than P_{cr} , but not larger than the yield load P_y . The load is then reversed to $-P_3$ such that $P_3 > P_1$. (Unloading follows a straight line joining the point of return and point representing cracking in the other direction)
4. One or more loading cycles have occurred. The load is zero. (To construct the loading curve, connect the point at zero load to the point reached in the previous cycle, if that point lies on the primary curve or on a line aimed at a point on the primary curve. If the previous loading cycle contains no such point, go to the previous cycle and continue the process until such a point is found. Then connect that point to the point at zero load. **EXCEPTION:** If the yield point has not been exceeded and if the point at zero load is not located within the horizontal projection of the primary curve for that direction of loading, connect the point at zero load to the yield point to obtain the loading slope)
5. The yield load P_y is exceeded in one direction. (Unloading curve follows the slope given by the following equation $K_r = k_y \left(\frac{D_y}{D} \right)^{0.4}$ in which, k_r = slope of unloading curve, k_y = slope of line joining the yield point in one direction to the cracking point in the other direction, D = maximum deflection attained in the direction of the loading and D_y = deflection at yield)
6. The yield load is exceeded in one direction but the cracking load is not exceeded in the opposite direction. (Unloading follows point 5. Loading in the other

direction continues as an extension of the unloading line up to the cracking load. Then, the loading curve is aimed at the yield point)

7. One or more loading cycles have occurred. (If the immediately preceding quarter cycle remained on one side of zero load axis, unload at the rate based on point 2, 3 and 5 whichever governed in the previous loading history. If the immediately preceding quarter cycle crossed the zero load axis, unload at 70% of the rate based on point 2, 3 and 5, whichever governed in the previous loading history, but not at a slope flatter than the immediately preceding loading slope)

This model includes (a) stiffness changes at flexural cracking and yielding, (b) hysteresis points/rules for inner hysteresis loops inside the outer loop and (c) unloading stiffness degradation with deformation. The response point moves toward a peak of the one outer hysteresis loop. The modified Takeda model is shown in figure 81.

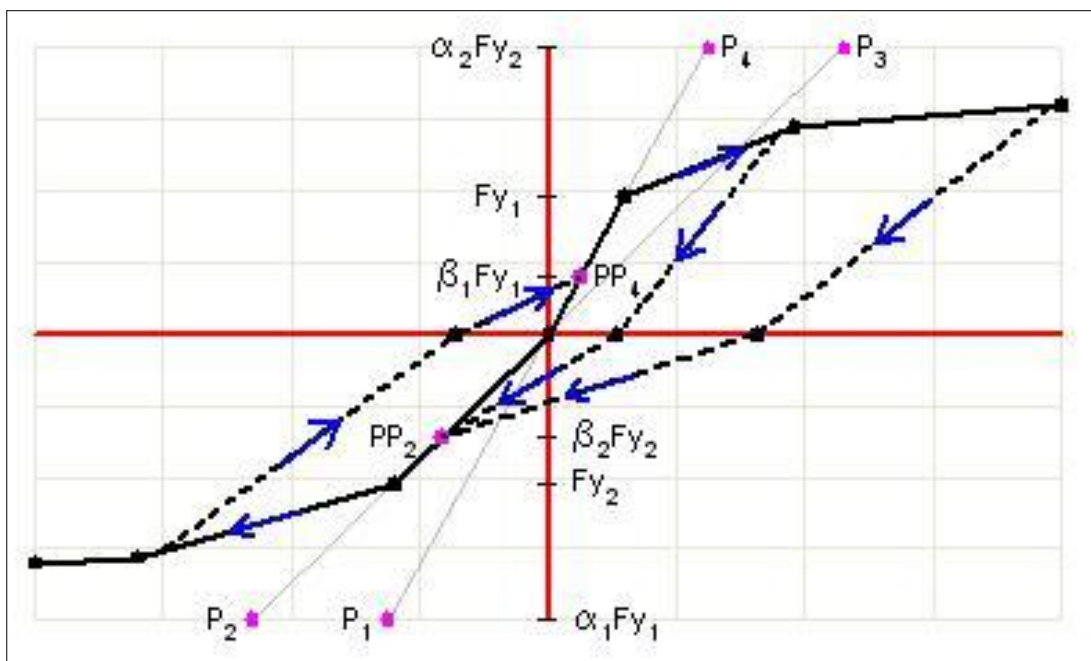

Figure 81: Modified Takeda model

9.1.3 Modelling of Brick Masonry Building:

Brick Masonry is a two phase anisotropic material with brick units and mortar joints set in a regular interval. Structure is discretized such that each brick unit is represented by a set of square elements where mortar joints lie in their corresponding contact edges. For different brick laying pattern, a scheme is developed so that portion of overlapping of upper layer brick to the immediate below one can be chosen so that desired bonding pattern could be achieved with exact location of the mortar joint. The staggered location of head joint will be matching as to lie in contact edge of end element of each brick unit. In spring level, springs that lie within one unit of brick are termed as 'unit springs'. For those springs, the corresponding domain material is brick as isotropic nature and they are assigned to structural properties of brick. Springs those accommodate mortar joints are treated as 'joint springs'. They are defined by equivalent properties based on

respective portion of unit and mortar thickness. The configuration of brick units, joints and their representation in his study is shown in figure 82. The initial elastic stiffness values of joint springs are defined as in Eqs. (4) and (5).

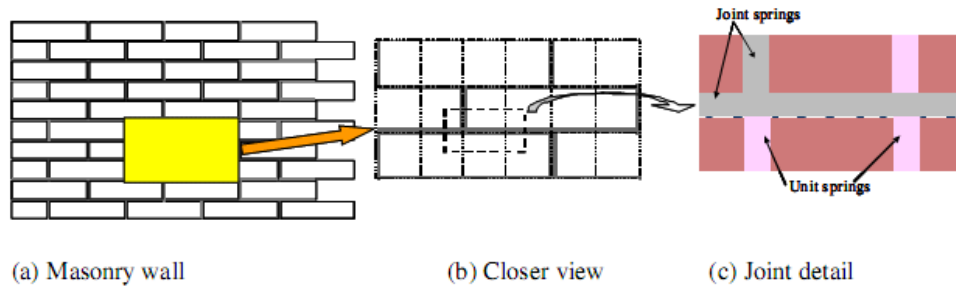

Figure 82: Masonry discretization (Pandey et al, 2004)

$$K_{nunit} = \frac{E_u t d}{a}; K_{njoint} = \frac{E_u E_m t d}{E_u \times t_h + E_m (a - t_h)} \quad (4)$$

$$K_{sunit} = \frac{G_u t d}{a}; K_{sjoint} = \frac{G_u G_m t d}{G_u \times t_h + G_m (a - t_h)} \quad (5)$$

Where E_u and E_m are Young's modulus for brick unit and mortar, respectively, whereas G_u and G_m are shear modulus for the same. Thickness of wall is denoted by 't' and 't_h' is mortar thickness. Dimension of element size is represented by 'a' and 'd' is the fraction part of element size that each spring represent. While assembling the spring stiffness for global matrix generation, contribution of all springs around the structural element are added up irrespective to the type of spring. In the sense, for global solution of problem, there is no distinction of different phase of material but only their corresponding contribution to the stiffness system.

Material model used was a composite model that takes account brick and mortar with their respective constitutive relation with elastic and plastic behaviour of hardening and softening is implemented. Brick springs were assumed to follow principal stress failure criteria with linear elastic behaviour. Once there is splitting of brick reaching elastic limit, normal and shear stress are assumed not to transfer through cracked surface in tensile state. The brick spring's failure criterion is based on a failure envelope given by:

$$\frac{f_b}{f'_b} + \frac{f_t}{f'_t} = 1 \quad (6)$$

Where f_b and f_t are the principal compression and tensile stresses, respectively, and f'_b and f'_t are the uniaxial compression and tensile strengths, respectively. Coulomb's

friction surface with tension cut-off is used as yield surface after which softening of cohesion and maximum tension takes place in exponential form as a function of fracture energy values and state variables of damage. The cohesion and bond values are constant till the stress first time when stress exceeds the respective failure envelopes. Figure 83 shows the degradation scheme of cohesion and bond respectively. Failure modes that come from joint participation of unit and mortar in high compressive stress is considered by linearized compression cap as shown in figure 84. The effective masonry compressive stress used for cap mode follows hardening and softening law as shown in figure 85. The tension cut-off, f_1 , and the sliding along joints, f_2 , exhibit softening behaviour whereas the compression cap experiences hardening at first and then softening. The failure surfaces used in this study derived from Lourenço, (1997), with some simplification are as given in equations. (7), (8) and (9).

$$f_1(\sigma, K_1) = \sigma - f_t \exp\left(-\frac{f_t}{G_f^I} K_1\right) \quad (7)$$

$$f_2(\sigma, K_2) = |\tau| + \sigma \tan(\phi_1) - c \exp\left(-\frac{c_t}{G_f^{II}} K_2\right) \quad (8)$$

$$f_3(\sigma, K_3) = |\tau| + \sigma \tan(\phi_2) \{(\sigma_3(K_3) - \sigma)\} \quad (9)$$

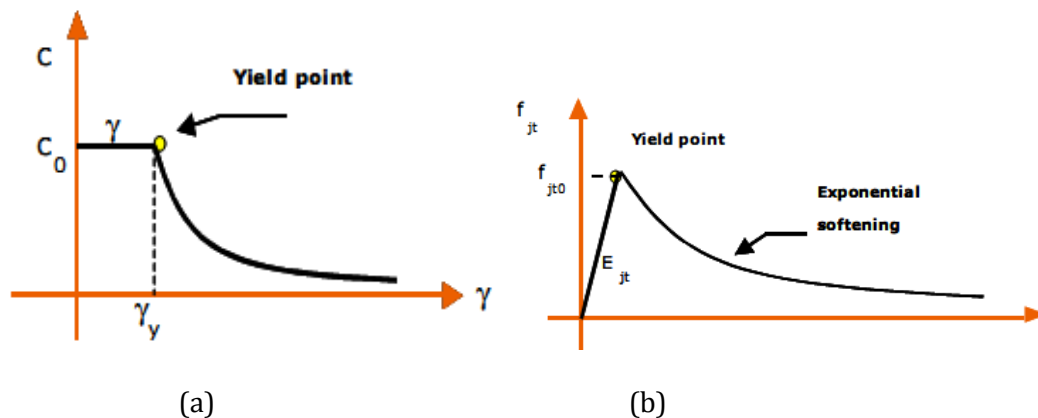

Figure 83: (a) Cohesion degradation, (b) Bond degradation (Pandey et al, 2004)

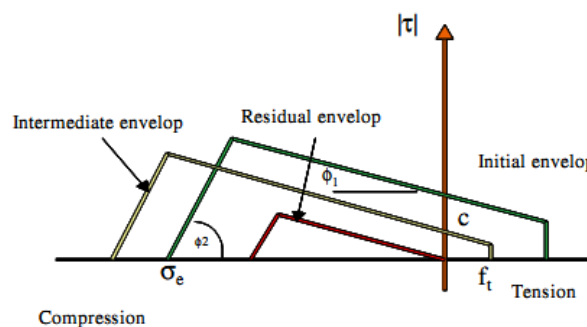

Figure 84: Failure criteria for joint spring (Sutcliffe et al, 2001)

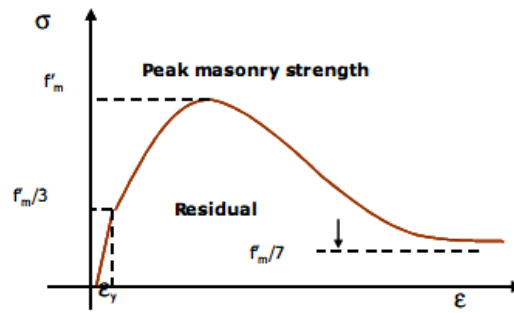

Figure 85: Hardening and softening applied for joint spring in compression cap (BishnuPandey et al, 2004)

Simulation of wall behaviour using AEM was made for experimental wall to compare between experimental observation and numerical results. Good agreement was observed between experimental results and numerical prediction. The analysis was extended for walls of practical dimension to estimate the behaviour under different construction and loading variables.

9.2 Detailed Analysis of Building:

This section provides the details of the building which were further used for the numerical modelling. Geometric details, material characteristic and loading pattern is described for these set of buildings.

9.2.1 Geometry Details:

Total 27 buildings were modelled out of 47 buildings whose details were collected during second stage of vulnerability analysis i.e. preliminary vulnerability assessment (PVA). Geometry details of these building include multiple parameters for different building typology.

RC Frame Buildings:

General information for these 8 buildings include latitude/ longitude, location, number of storey, year of construction, seismic zone, RVS score and use of the building. Geometry details of RC frame buildings include dimension in both X and Y direction, beam and column direction, details of staircase (width, riser and tread), plinth, sill and lintel height, slab thickness and width of internal and external walls. Details for all 8 buildings are provided below in the table 25:

Table 25: General information and geometry details of RC buildings from 1 to 4

Specification	Building I	Building II	Building III	Building IV
General Building Information				
Location	Mandi	Mandi	Hamirpur	Shimla
Latitude	31°32'02" N	31°32'4" N	31°40'80" N	31°05'39" N
Longitude	76°54'13" E	76°53'23" E	76°31'473" E	77°10'36" E
Year of Construction	-	-	2005	-
Storey	G+1	G+1	G+1	G+1
Seismic Zone	V	V	IV	V
RVS Score	61	95	125	135

Use of Building	Residential	Residential	Residential	Commercial
Structural Details				
Dimension in X Direction (m)	10.05	12.85	13.5	25.7
Dimension in Y Direction (m)	6.6	8.7	10.7	6.35
Storey Height (m)	3	0.23x0.46	0.25x0.34	0.40x0.45
Column dimension (m ²)	0.3x0.3	0.23x0.46	0.23x0.22	0.40x0.50
Beam dimension (m ²)	0.3x0.3	3	3	3.6
Stair Case Width (m)	1	1	1	-
Riser (m)	0.20	0.20	0.20	-
Tread (m)	0.25	0.25	0.25	-
Plinth Height (m)	0.4	0.4	0.4	0.4
Sill Height (m)	0.7	0.65	0.65	0.65
Lintel Height (m)	2	2	2	2
Slab Thickness (m)	0.1	0.125	0.25	0.25
External Wall Thickness (m)	0.23	0.23	0.23	0.23
Internal Wall Thickness (m)	0.1	0.1	0.1	0.1

Table 26: General information and geometry details of RC buildings from 5 to 8

Specification	Building V	Building VI	Building VII	Building VIII
General Building Information				
Location	Shimla	Hamirpur	Hamirpur	Una
Latitude	31°40'58" N	-	-	31°28'66" N
Longitude	77°10'10" E	-	-	76°16'48" E
Year of Construction	-	2000	-	2013
Storey	G+1	G+1	G+1	G
Seismic Zone	V	IV	IV	IV
RVS Score	115	115	83	130
Use of Building	Residential	Residential	Commercial	Residential
Structural Details				
Dimension in X Direction (m)	10.55	11.4	14.4	11.45
Dimension in Y Direction (m)	7.23	9.4	6.8	8.65
Storey Height (m)	0.30x0.30	0.30x0.30	0.25x0.28	0.30x0.30
Column dimension (m ²)	0.30x0.30	0.23x0.22	0.23x0.22	0.30x0.30
Beam dimension (m ²)	3	3	3.1	3
Stair Case Width (m)	-	1	0.95	-
Riser (m)	-	0.18	0.2	-
Tread (m)	-	0.23	0.25	-
Plinth Height (m)	0.4	0.4	0.4	0.4
Sill Height (m)	1	0.65	0.65	1
Lintel Height (m)	2.85	2	2	2.85
Slab Thickness (m)	0.25	0.25	0.25	0.25
External Wall Thickness (m)	0.23	0.23	0.23	0.23
Internal Wall Thickness (m)	0.1	0.1	0.1	0.1



Figure 86: General View of RC Buildings

Brick Masonry Buildings:

General information for these 8 buildings include latitude/ longitude, location, number of storey, year of construction, seismic zone, RVS score and use of the building. Geometry details of brick masonry buildings include dimension in both X and Y direction, beam and column direction, details of staircase (width, riser and tread), plinth, sill and lintel height, slab thickness, live load, floor finish, type of soil and thickness of internal and external walls. Details for all 8 buildings are provided below in the table 27:

Table 27: General building information of brick masonry buildings

S. No	Specification	Building I	Building II	Building III	Building IV
1	Location	Kangra	Una	Kangra	Hamirpur
2	Latitude	32°13'42.42" N	31°24'12.42" N	32°11'38.52" N	31°41'05.04" N
3	Longitude	76°10'10.62" E	76°20'13.14" E	76°13'55.14" E	76°31'26.70" E
4	Year of Const.	2013	2003	1988	1970
5	Storey	One	Two	One	One
6	Seismic Zone	V	IV	V	IV
7	RVS Score	83	123	105	83
8	Use of Building	Residential	Educational	Residential	Residential
9	Remark	Unsymmetric	-	Symmetric	-

S. No	Specification	Building V	Building VI	Building VII	Building VIII
1	Location	Kangra	Una	Mandi	Una
2	Latitude	32°11'38.52" N	31°24'22.14" N	31° 32' 31" N	31°27'51.36" N
3	Longitude	76°13'55.14" E	76°20'32.16" E	76° 54' 01" E	76°16'04.80" E
4	Year of Const.	1978	1973	1995	1999
5	Storey	One	One	Three	Two
6	Seismic Zone	V	IV	V	IV
7	RVS Score	105	105	52	113
8	Use of Building	Residential	Residential	Residential	Residential
9	Remark	Symmetric	-	Vertical irregularity	-

Table 28: Geometry details of all brick masonry buildings

Building	I	II	III	IV	V	VI	VII	VIII
Dimension in X Direction (m)	11.15	34	16.2	7.4	15.9	8	14.7	8.8
Dimension in Y Direction (m)	10.5	8.1	7.4	6.8	7.9	10.8	11.3	10.4
Storey Height (m)	3.1	3	2.85	3	3	2.9	3	3
Stair Case Width (m)	1	2	0.9	-	0.9	0.9	1	0.9
Riser (m)	0.23	0.23	0.2	-	0.2	0.22	0.2	0.2
Tread (m)	0.25	0.25	0.25	-	0.2	0.26	0.25	0.25
Plinth Height (m)	0.4	0.2	0.35	0.2	0.5	0.2	0.3	1.05
Sill Height (m)	0.65	0.85	0.75	0.7	0.7	0.6	0.6	0.6
Lintel Height (m)	2	2.45	2	1.95	1.9	1.8	1.9	1.8
Live Load (kN/m ²)	1.25	5	3	-	3	3	3	3
Floor Finish (kN/m ²)	1	1	1	-	1	1	1	1
Type of Soil	II	II	II	II	II	II	II	II
Slab Thickness (m)	0.15	0.15	0.15	-	0.2	0.12	0.15	0.2
External Wall Thickness (m)	0.23	0.27	0.25	0.4	0.25	0.23	0.25	0.2
Internal Wall Thickness (m)	0.1	0.25	0.25	0.4	0.25	0.23	0.25	0.2
Concrete Grade	NDT	NDT	NDT	NDT	NDT	NDT	NDT	NDT
Steel Grade	Fe415	Fe415	Fe415	-	Fe415	Fe415	Fe415	Fe415



Figure 87: General View of brick masonry Buildings

Stone Masonry Buildings:

Geometry details of stone masonry buildings include dimension in both X and Y direction, type of stone, stone dimensions, beam and column direction, details of staircase (width, riser and tread), plinth, sill and lintel height, slab thickness, live load, floor finish, type of soil and thickness of internal and external walls. Details for all 2 buildings are provided below in the table 29:

Table 29: Geometry details of stone masonry buildings

Description	Building 1	Building 2
Structure Typology	Stone Masonry	Stone Masonry
Latitude and Longitude	32°5'47" N, 76°15'54" E	32°12'24" N, 76°19'23" E
RVS Score	110	115
Type of stone	Sandstone	Sandstone
Stone Dimensions	0.24 x 0.12 x 0.12	0.24 x 0.12 x 0.12
Dimension in X Direction	5.01	20.64
Dimension in Y Direction	8.95	21.00
Storey Height Ground Floor	3.2	6.60
Storey Height First Floor	NA	3.4
Stair Case Width	NA	1.9
Riser	NA	0.23
Tread	NA	0.28
Plinth Height	0.45	

Description	Building 1	Building 2
Sill Height	0.90	0.55
Soil Type	II Medium	II Medium
Slab Thickness	NA	0.20
External Wall Thickness	0.15	0.40
Internal Wall Thickness	0.15	0.40



Figure 88: General View of stone masonry Buildings

Rammed Earth Buildings:

In this report, seven rammed earth buildings are selected for further analysis. These buildings are selected based on RVS score. Every three buildings are selected from low, medium and high RVS scores. From the analysis, the statistics are as follows:

mean - 2std. dev = 82;
 mean - std. dev = 93;
 mean = 104;
 mean + std. dev = 115;
 mean + 2std. dev = 126;

Buildings dimension in both X and Y directions were measured. The above values are obtained from normal distribution curve of rammed earth buildings. The normal distribution curve depends on mainly two factors, (i) mean and (ii) standard deviation. The mean indicates the position of center and standard deviation indicates height and width of the curve. Rammed earth buildings are selected from low to high RVS score or collapse to no damage state. For this purpose, the range of RVS score is selected into mean, mean \pm 1 and 2 std. dev. It means 68% of the area under the curve falls within $1\pm$ std. dev. and 95% of the area under the curve falls within $2\pm$ std. dev.

Table 30: Geometry details of rammed earth buildings

S.No	Buildings	X dimension (m)	Y dimension (m)
1.	Building 1	2.7	1.7
2.	Building 2	4.0	2.2
3.	Building 3	6.5	2.0

S.No	Buildings	X dimension (m)	Y dimension (m)
4.	Building 4	5.0	1.8
5.	Building 5	5.7	3.5
6.	Building 6	3.5	3.5
7.	Building 7	3.0	3.0



Figure 89: General View of rammed earth Buildings

Hybrid Buildings:

In the final stage of vulnerability assessment, two hybrid buildings were selected for numerical modelling. Hybrid buildings are those buildings which demonstrate two different construction type on individual floor. One building is the combination of Brick and RC frame structure and another one is the combination of brick and wooden structures on separate floor.

Geometry details of stone masonry buildings include dimension in both X and Y direction, number of storeys and their heights, staircase width, slab thickness and thickness of internal and external walls. Details for both buildings are provided below in the table 31:

Table 31: Structural and geometry details of hybrid building 1 and 2

Structural Details	Building-I	Building-II
Type of Materials	Brick and RC	Brick and Wood
Latitude and Longitude	32.13N, 76.10E	31.6N, 77.10E
RVS Score	83	54
Dimension in X Direction (m)	7	12.25
Dimension in Y Direction (m)	7.4	15.65
No. of Storeys	2	3
Storey Height Ground Floor (m)	2.9	2.9
Storey Height First Floor (m)	2.9	2.9
Stair Case Width (m)	0.9	0.9
Slab Thickness (m)	0.12	0.10
External Wall Thickness (m)	0.24	0.24
Internal Wall Thickness (m)	0.24	0.24



Figure 90: General View of hybrid buildings

9.2.2 Material Properties:

Poisson's ratio = 0.2

Modulus of Elasticity of rammed earth = 43560 kN/m²

Tension resistance = 190kN/m²

Compressive resistance = 1947 kN/m²

Grade of concrete = M20

Grade of steel = Fe 415

9.2.3 Loading Pattern

In this analysis the loading is applied at the top of the structure. Since, all the above structures are single storey to four storeys, the load is applied at the top of structure. The results are same when the load is applied at one element or at entire row of the

elements. The analysis is done using displacement control. The applied displacement is 0.08 m for all rammed earth structures.

9.3 Pushover Analysis:

Pushover analysis is usually conducted to evaluate existing buildings and retrofit them. It can also be applied for new structures. When an earthquake occurs, the structures must undergo damage to dissipate seismic energy. To design such a structure, it is necessary to know its performance and collapse pattern. To know performance and collapse pattern, nonlinear static procedures are helpful. It is an incremental static analysis used to determine the force-displacement relationship, or the capacity curve, for a structure. The analysis involves applying horizontal loads, in a prescribed pattern, onto the structure incrementally; pushing the structure and plotting the total applied lateral force and associated lateral displacement at each increment, until the structure achieve collapse condition. A plot of the total base shear versus roof displacement in a structure is obtained by this analysis that would indicate any premature failure or weakness.

Pushover analysis is done for all the above structures. To get the base shear vs roof displacement curve for a structure, the structure is pushed using either load control or displacement control. In this analysis displacement control is used till complete collapse of the structure. Number of iterations is one of the major parameter for this analysis. For this purpose, a case study is done for 50, 100, 150, 200, 250 and 300 iterations (figure 91 & 92). As the number of iterations increases, the base shear of structure comes down and gets saturate for further increments of iterations. From the analysis, it is concluded that the number of iterations is fixed to 200. The base shear vs roof displacement plot for all type of structure in both X and Y directions are shown from figure 91 to 97. The stiffness of the structure getting reduced when the first crack starts or the first spring fails. The spring fails when the principle stress exceeds the limited value. When the structure reaches the peak load value in the load vs displacement curve, it starts coming down for further increase in the displacement. Base shear of the structure is calculated with respect to roof displacement. For each roof displacement, base shear is calculated as the summation of horizontal forces at the bottom of each column. If the analysis is in load control, it is necessary to calculate displacement and vice-versa.

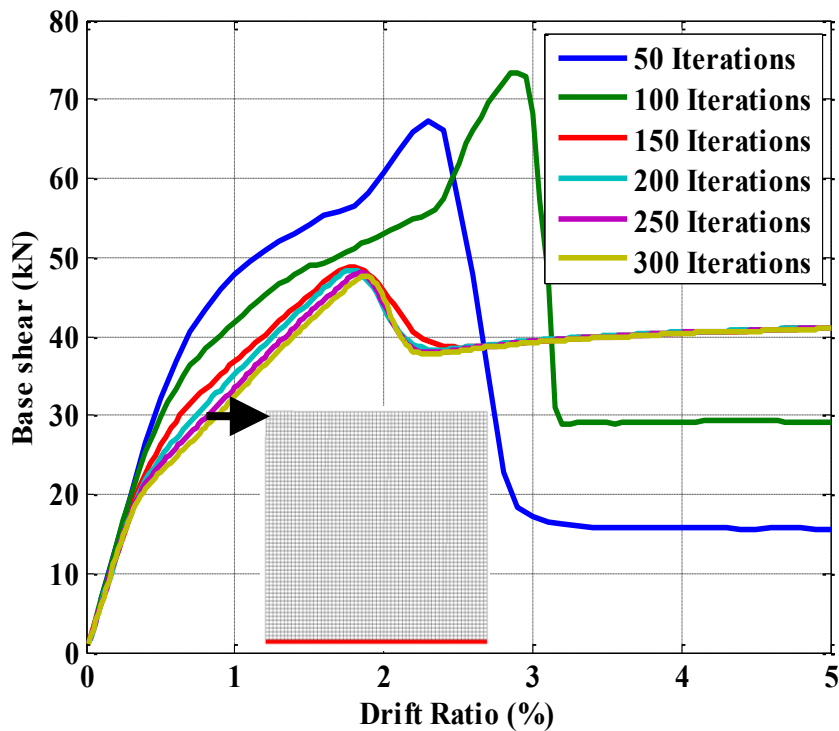

Figure 91: Base shear vs drift ratio for rammed earth building in X direction

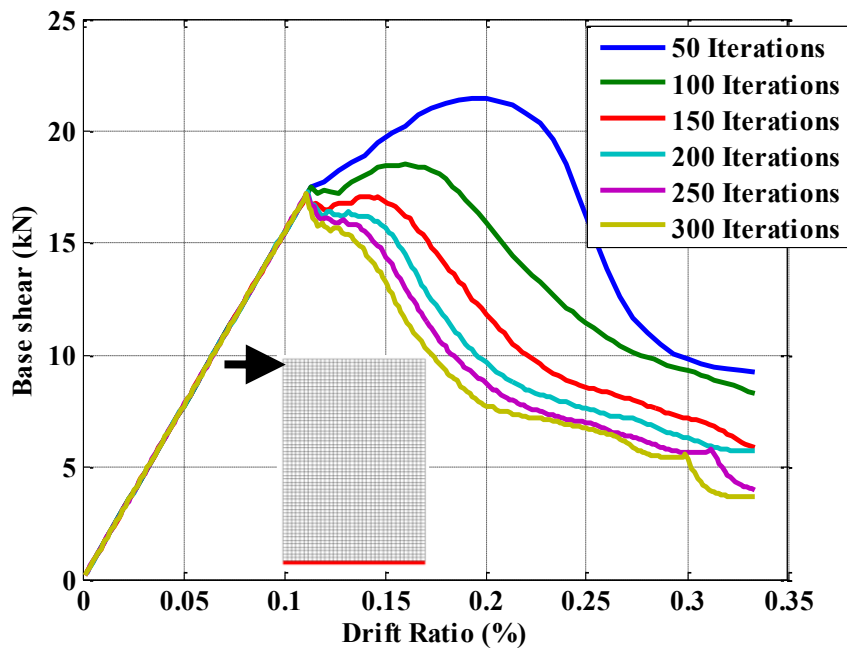

Figure 92: Base shear vs drift ratio for rammed earth building in Y direction

Figure 93 to 97 represent the pushover curve for all five different building type. In RC frame structure, first crack appear at a later stage and higher lateral force due to frame action. Collapse of building in RC frame building in not a sudden phenomenon like other building types. Brick Masonry buildings does not go for much relative displacement before the appearance of cracks.

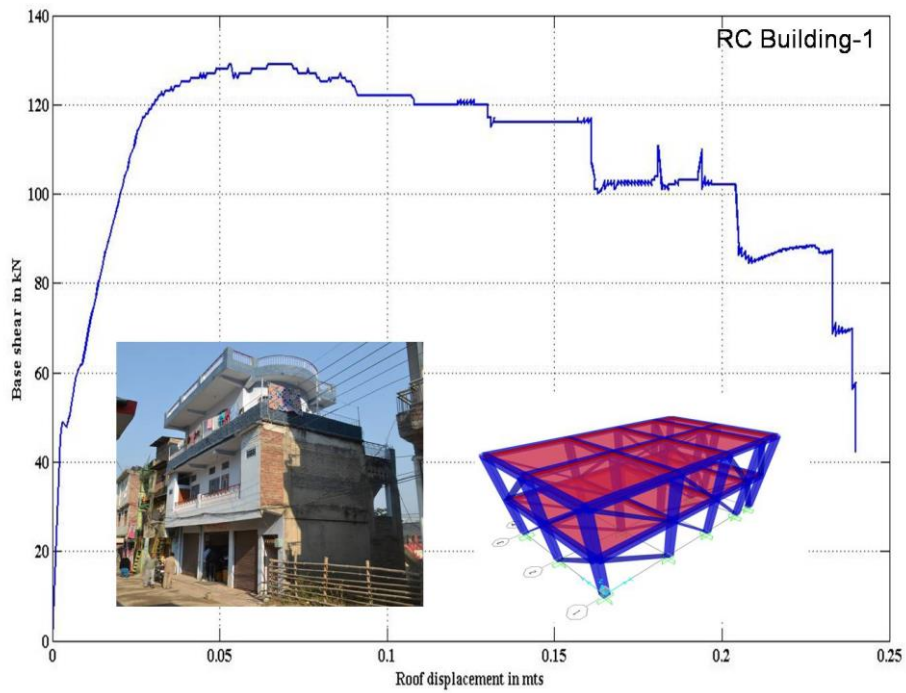

Figure 93: Base shear Vs Roof Displacement for RC Frame Building

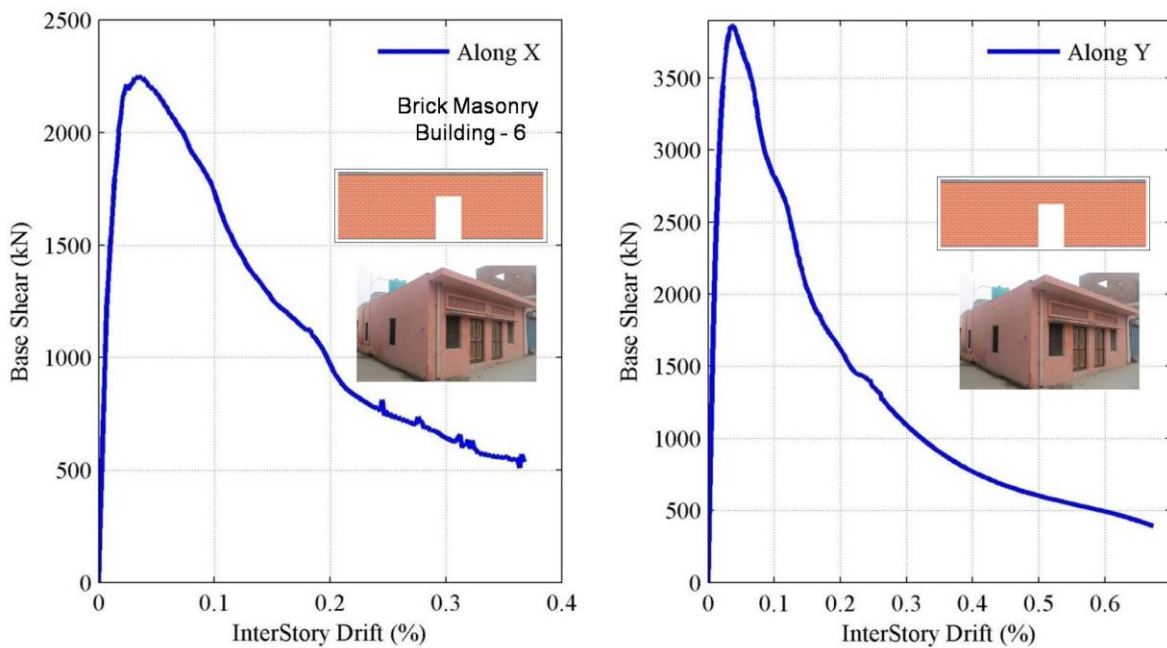

Figure 94: Base Shear Vs Interstorey Drift for Brick Masonry Building in X and Y Direction

The pushover curve pattern depends on three parameters Initial stiffness, Strength and Ductility. Brick masonry building shown in figure 94 has higher strength along Y direction compared to X direction because of higher shear area and lesser aspect ratio.

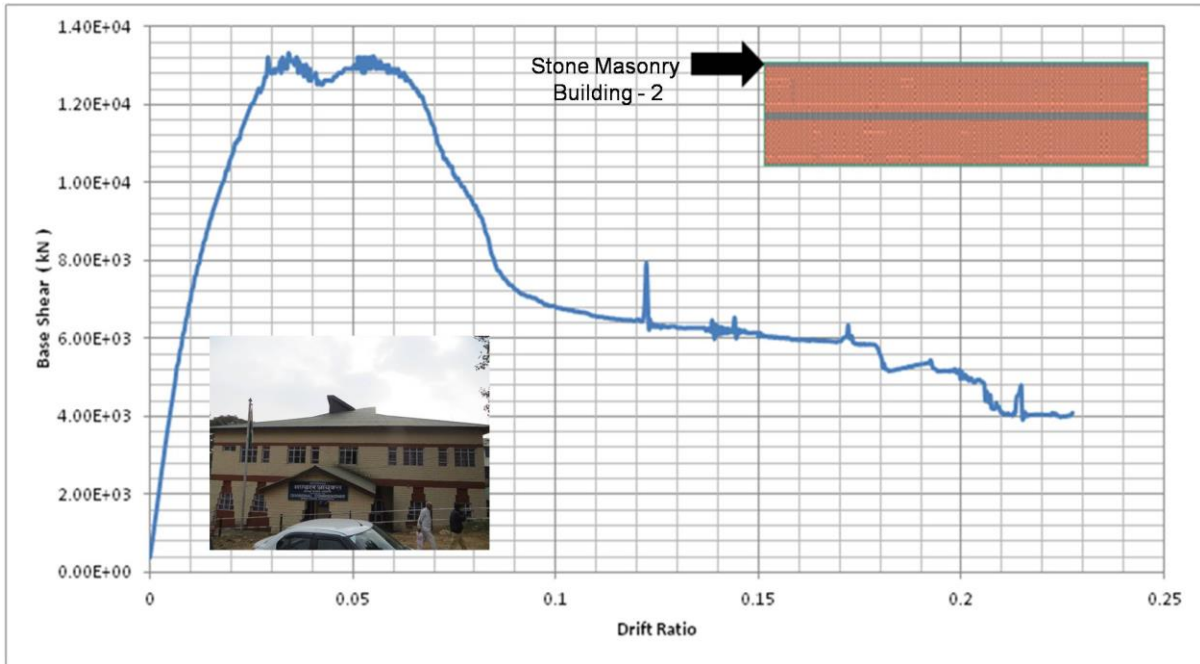

Figure 95: Base shear vs. drift ratio for stone masonry buildings

It is observed that the building with the low slenderness ratio (H/L) and higher shear area is said to have higher strength capacity compare to vice versa. This is because of the fact that lesser the shear area, lesser the resistance offered to the load, thus the capacity of the building will be ultimately lesser in that particular direction.

Rammed earth building being brittle in nature collapse rapidly after developing the first crack in the building at relatively less lateral load (figure 96).

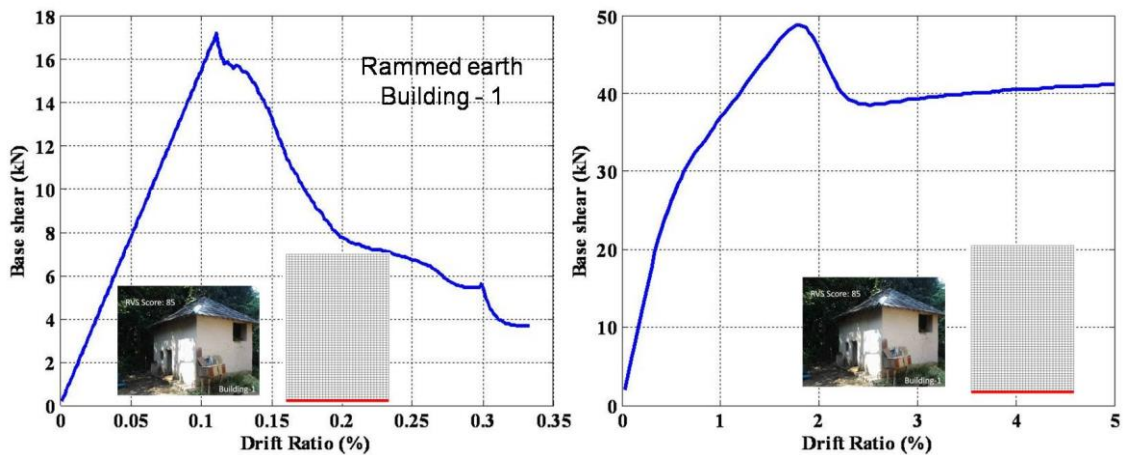

Figure 96: Base Shear Vs Drift Ratio for Rammed Earth Building

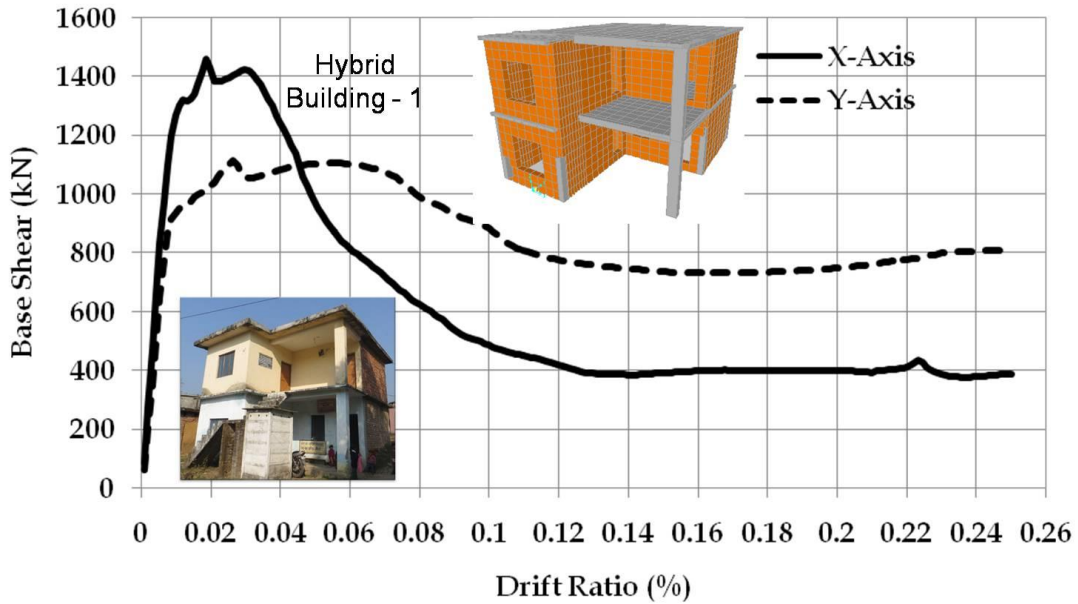

Figure 97: Base shear vs. drift ratio for hybrid buildings

9.4 Fragility Curve:

The area under the load vs displacement curve is the total energy dissipated in the structure. We calculated elastic and inelastic energy of the structure at each and every displacement. The schematic diagram represents calculation of damage from pushover curve shown in figure 98. The damage parameter (D) is denoted as the ratio of inelastic energy to the total energy of the structure. Damage parameter is a dimensional less quantity. The dissipated energy at point 'i' is inelastic energy in damage calculation. The dissipated energy till collapse gives rise to total energy in damage calculation. With these damage values, fragility curve has generated which is in terms of displacement. It is necessary to convert displacement into acceleration. Following is the procedure:

Step-1: Spectral accelerations (S_a) are calculated using $4\pi(SD)/T^2$. Where SD=spectral displacement and T=time period.

Step-2: The spectral displacement (SD) values are calculated from base shear relation

$$\begin{aligned}
 V &= \alpha \cdot S_a \cdot W; \\
 \Delta_{\text{roof}} &= \text{PF} \cdot \text{SD} \cdot \phi_{\text{roof}}; \\
 \text{SD} &= \frac{\Delta_{\text{roof}}}{\text{PF} \cdot \phi_{\text{roof}}}
 \end{aligned}
 \tag{7}$$

Where, V-base shear, W-seismic weight of structure, PF-participation factor.

Step-3: Fragility curve can be drawn with acceleration and corresponding damage.

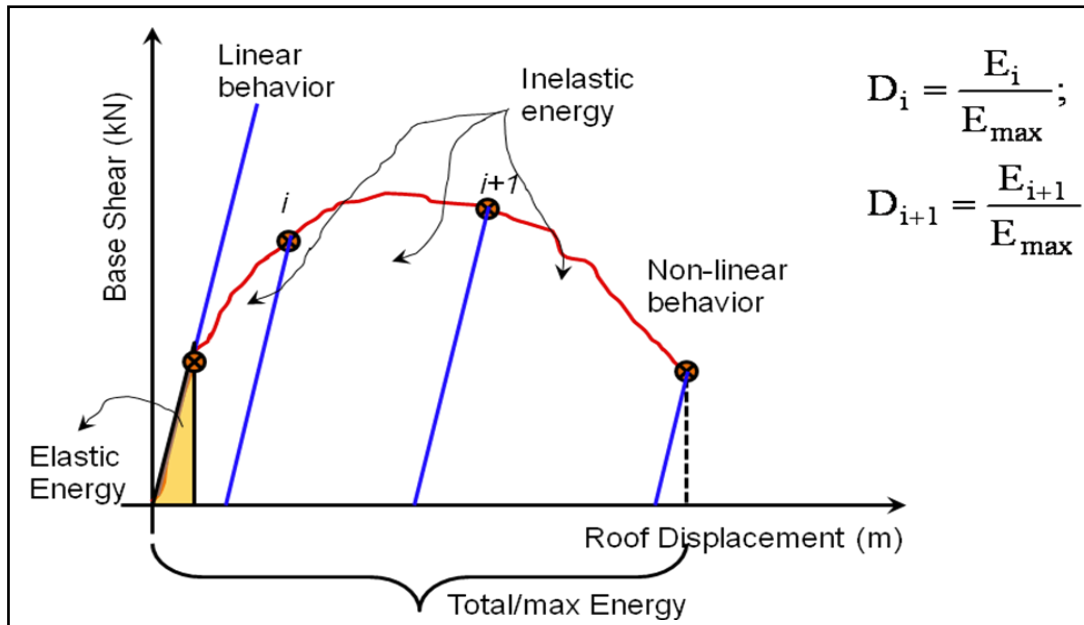

Figure 98: Schematic diagram represents Base shear vs roof displacement of building for calculating damage

The damage parameter (D) is classified as no damage ($D < 0.2$), slight damage ($0.2 < D < 0.4$), moderate damage ($0.4 < D < 0.6$), heavy damage ($0.6 < D < 0.8$) and collapse ($D > 0.8$). The PGA values with respect to RVS scores for damage categories are found out from fragility curves. The state of damage of all typology of buildings can be found out from figure 99, if PGA value of the region and RVS score of building is known.

Buildings will be subjected to lateral forces in both X and Y direction. It is important to note that the structure may have different amount of damage along both directions, but the seismic performance of the building should be based on the direction having higher damage. From the study done it has been observed that masonry building having more opening had more amount of damage in spite proper structural configuration. The locations of opening also play an important role on capacity of structure. Openings are to be avoided at the junctions or near to junctions to reduce the damage. All most all the masonry buildings used Un-Reinforced masonry type of construction; damage can be reduced further using Reinforced masonry type of construction.

Seismic performance of the structures can be improved significantly by proper structural configuration, proper location of openings, horizontal bands, avoiding heavy overhangs and making structure symmetric about both axis.

In case of seismic retrofitting of structures, detailed structural assessment is performed at component level. A knowledge factor (k) is introduced to account for the uncertainty with regard to the reliability of available information on the configuration and condition of a component (IITK-GSDMA Code). The factor K can be established from study of the original documents of the buildings or non-destructive testing of representative members. Using established field tests for materials in the building, present day strength can be estimated and used for evaluation purposes even when it is higher than the design strength. Force-based and displacement-based methods are adopted for detailed assessment. Force-based assessment is based on determining the probable strength and ductility of the critical mechanism of post-elastic deformation of the lateral force-resisting elements whereas, displacement-based methods place a direct emphasis

on establishing the ultimate displacement capacity of lateral force resisting elements. In this analysis, a knowledge factor 1.0, 0.8, 0.5, 0.5 and 0.2 is used for RC, brick masonry, stone masonry, rammed earth and hybrid buildings respectively to account for uncertainties of fragility curves.

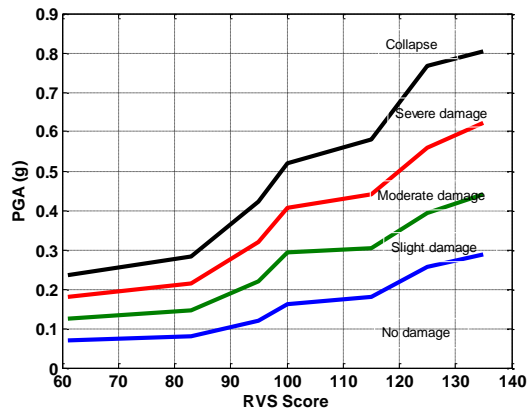

(a) Reinforced concrete buildings

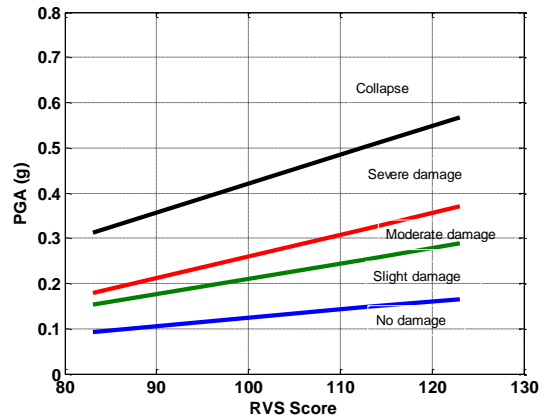

(b) Brick masonry buildings

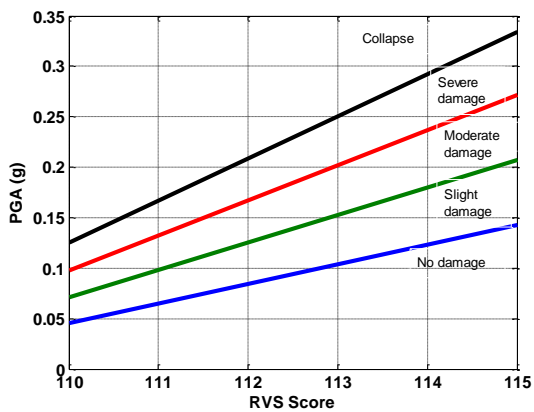

(c) Stone masonry buildings

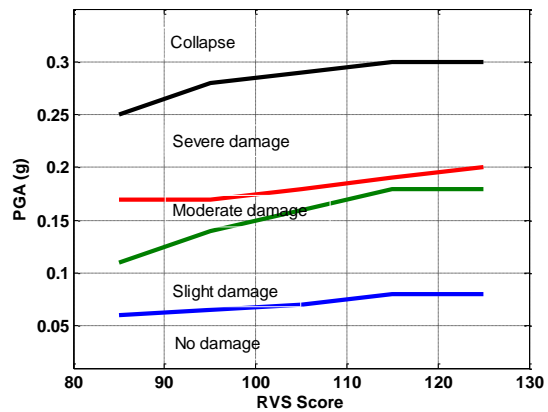

(d) Rammed earth buildings

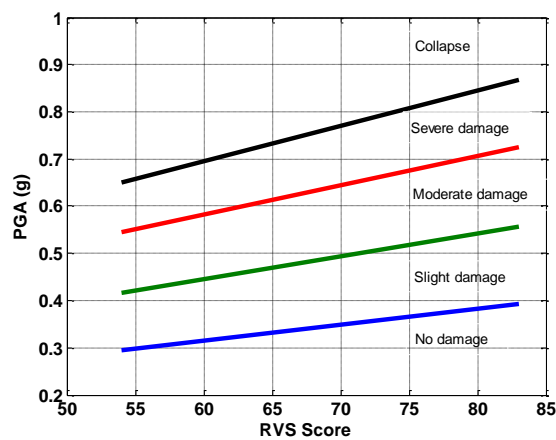

(e) Hybrid buildings

Figure 99: Generalized state of damage for different typology of w.r.t RVS scores

Above graphs (figure 99) correlating the RVS score of the buildings and PGA values of the location is developed for existing building stocks in the state of Himachal Pradesh. Five categories of damage are identified starting from no damage to full collapse of the building. If RVS score of the building is known, expected grade of damage of the building can be read from the above graph by knowing the PGA value of that particular site.

Fragility curve shows that a building with low RVS score means highly vulnerable building will suffer more damage at low intensity of earthquake only (low PGA value). For RC frame structures, a building with RVS score of 70 will suffer D3 or higher category of damage due to earthquake capable of producing PGA value of more than 0.14g.

Fragility curve of brick masonry building shows that buildings having RVS score of 85 will suffer D4 to D5 category of damage at the sites where PGA exceeds above 0.18g. A low vulnerable building having RVS score of 120 will sustain high intensity of earthquake. It will have damage of grade D1 and D2 only even at the PGA values of 0.15g to 0.27g.

Stone masonry and rammed earth buildings may receive sever damage (D4 and D5) at PGA values of 0.1 g and 0.16g only even though their RVS score vary from 85 to 110. Rammed earth wall being brittle in nature receive damage at early stage of deformation due to lateral forces. Stone masonry buildings lack in interlocking of masonry unit due to undressed/ rounded stone used in wall construction which may collapse even in minor shaking of low intensity of earthquake.

Hybrid and other buildings will sustain large earthquakes also with having any major damage. Most of the buildings will suffer D1 or D2 category of damage only.

9.5 Damage of the Building for different return periods of earthquake:

For calculating the expected level of damage of buildings during different intensity of earthquake, all the existing building stocks of the state of Himachal Pradesh has been categorize into five predominant category of building typology .i.e. Brick Masonry, stone masonry, rammed earth, RC frame buildings and Hybrid buildings. As roof of the wall does not contribute into the lateral load resisting of the structure, different combination of roof-wall matrix (as per census of India 2011) are classified into the above mentioned five building typology. Burnt brick wall with different roof combination such as flat RC roof, GI/ Asbestos/ Metal sheet or slate/ stone roofing comes under brick masonry building category.

In India, MSK intensity scale was adopted (IS 1893:200). This intensity scale talks about level of damage of buildings for different building category (Table 34). As per IS 1893:2002, total building stock can be categorized in three types i.e. type A, B & C. Table 33 provides the description of different building types. Five predominant building typology of Himachal Pradesh defined for building vulnerability assessment can be grouped under these three building types. Rammed earth and undressed stone masonry buildings are categorized under type while brick masonry, dressed stone masonry and hybrid buildings under type B and RC frame buildings comes under type C. Damage

state of buildings is defined into five grade from D1 to D5 where D1 is no or slight damage and D5 is the total collapse of the building (Table 32).

Table 32: Classification of Damage Grade

Grade of Damage	Description of Damage
Grade 1(D1)	Slight damage Fine cracks in plaster: fall of small pieces of plaster.
Grade 2 (D2)	Moderate damage Small cracks in plaster: fall off fairly large pieces of plaster: pan tiles slip off: cracks in chimneys parts of chimney fall down.
Grade 3 (D3)	Large and deep cracks in plaster: fall of chimneys.
Grade 4 (D4)	Gaps in walls: parts of buildings may collapse: separate parts of the buildings lose their cohesion: and inner walls collapse.
Grade 5 (D5)	Total collapse of the buildings.

(Source: Technical Document of Seismic Vulnerability Assessment Methods for Buildings, NDMA 2013)

Table 33: Type of Buildings (IS 1893: 2002)

Type of Structure (Buildings)	Description	Building Typology in Vulnerability Assessment
Type A	Building in field-stone, rural structures, unburnt-brick houses, clay houses.	Rammed Earth, Stone Masonry
Type B	Ordinary brick buildings, buildings of large block and prefabricated type, half timbered structures, buildings in natural hewn stone.	Brick Masonry, Stone Masonry, Hybrid
Type C	Reinforced buildings, well built wooden structures.	RC Frame , Hybrid

Table 34: MSK-64 earthquake intensity scale adopted in India (IS:1893-2002)

Intensity	Grade Description
I	Not noticeable
II	Scarcely noticeable
III	Weak, partially observed only
IV	Largely observed
V	Awakening
VI	Frightening

Intensity	Grade Description
VII	Damage of Buildings
VIII	Destruction of Buildings
IX	General Damage of Buildings
X	General Destruction of Buildings
XI	Destruction
XII	Landscape Changes

As per Vulnerability Atlas of India (BMTPC,2006), Himachal Pradesh lies in the seismic zone of IV and V. Seismic zone IV areas may expect earthquake of MSK intensity upto VIII and an earthquake of intensity IX or above can strike in the areas of seismic zone V (IS 1893:2002). PGA values in the seismic zone of IV varies from 0.08g to 0.147g while places with expected PGA values of more than 0.147g, are classified in seismic zone V (TARU Analysis 2014).

As census of India (2011) only provides the housing data in terms of census houses / households, a methodology was developed to calculate the tentative number of buildings in tehsil level. Sample of surveyed buildings was considered as the representative of the universal data to arrive the number of buildings.

Table 35: Estimated Number of Buildings in Himachal Pradesh

District	Brick Masonry	Stone Masonry	Rammed Earth	RC Frame	Hybrid and Others	Total
BILASPUR	26798	20349	11172	483	570	59372
CHAMBA	12379	46646	7249	147	1619	68040
HAMIRPUR	46860	5822	36479	364	904	90429
KANGRA	135234	14857	100317	642	2792	253842
KINNAUR	1895	8523	431	765	2546	14160
KULLU	13149	41010	2456	992	5344	62951
LAHAUL & SPITI	167	2573	2186	15	106	5047
MANDI	42957	95666	17191	1823	2575	160212
SHIMLA	28852	49585	11004	850	9653	99944
SIRMAUR	26598	25801	4545	706	1929	59579
SOLAN	44552	16571	11199	766	2490	75578
UNA	60448	2508	12687	873	2118	78634
Total	439889	329911	216916	8426	32646	1027788

Source: TARU Analysis 2014

The level of earthquake chosen as the basis of a deterministic analysis is usually measured in terms of estimated return period for probabilistic analysis. Generally return period is calculated for the design life of a residential building i.e. 50 years. 475 year return period is the most commonly used in seismic risk analysis and it is also basis for the design of India seismic codes such as IS 1893:2002. 475 year return period earthquake means the 10% probability of exceedance of an earthquake in 50 years. 2475 year return period means the 2% probability of exceedance in 50 years.

Expected level of building damage has been calculated for entire residential and residential cum other use building stock of Himachal Pradesh at different return period of earthquake i.e. 100, 200, 475 and 2475 year return period. For 100 and 200 year return period earthquake, most of the buildings will suffer only D1 and D2 category of damage (Table 36 & 37). Only buildings situated in Hamirpur, Mandi, Chamba and Una will show D4 and D5 category of damage under 200 year return period of earthquake which have the 22% probability to exceed in 50 years period. For 200 year return period of earthquake, moderate to heavy damage may occur in most of the districts except Kinnaur, Shimla, Sirmaur and Solan.

Table 36: Percentage of Building Damage due to Earthquake of 100 year return period

District	D1	D2	D3	D4	D5
Bilaspur	67%	33%	0%	0%	0%
Chamba	67%	32%	1%	0%	0%
Hamirpur	51%	42%	5%	0%	2%
Kangra	58%	42%	0%	0%	0%
Kinnaur	97%	3%	0%	0%	0%
Kullu	40%	60%	0%	0%	0%
Lahaul & spiti	55%	45%	0%	0%	0%
Mandi	45%	46%	9%	0%	0%
Shimla	88%	12%	0%	0%	0%
Sirmaur	77%	23%	0%	0%	0%
Solan	85%	15%	0%	0%	0%
Una	92%	8%	0%	0%	0%

Table 37: Percentage of Building Damage due to Earthquake of 200 year return period

District	D1	D2	D3	D4	D5
Bilaspur	67%	10%	24%	0%	0%
Chamba	66%	24%	8%	2%	1%
Hamirpur	42%	22%	29%	4%	2%
Kangra	54%	33%	13%	0%	0%
Kinnaur	97%	3%	0%	0%	0%
Kullu	40%	16%	45%	0%	0%
Lahaul & spiti	41%	57%	2%	0%	0%
Mandi	45%	6%	25%	24%	0%
Shimla	88%	12%	0%	0%	0%
Sirmaur	48%	52%	0%	0%	0%
Solan	85%	15%	0%	0%	0%
Una	81%	11%	7%	1%	0%

475 and 2475 year return period earthquakes will cause excessive economic damage and buildings may get affected severely leading to either partial or full collapse. Buildings sustaining D4 and D5 category of damage may also have huge casualties depending upon the time of earthquake. Table 38 shows that in terms of percentage of damaged buildings under D4 and D5, worst affected areas may be Bilaspur, Chamba, Hamirpur, Kangra, Kullu, Lahul & Spiti, Mandi and Sirmaur. Kinnaur is not expected to suffer much damage as most of the building construction in Kinnaur is still old traditional type where alternate layer of wood and stone has been used for wall construction. This traditional building typology has performed well even in the past earthquakes in Himachal Pradesh.

Table 38: Percentage of Building Damage due to Earthquake of 475 year return period

District	D1	D2	D3	D4	D5
Bilaspur	66%	0%	1%	19%	14%
Chamba	66%	0%	0%	29%	5%
Hamirpur	19%	27%	5%	41%	8%
Kangra	47%	7%	7%	36%	3%
Kinnaur	94%	3%	0%	3%	0%
Kullu	34%	6%	0%	17%	44%
Lahaul & spiti	41%	0%	0%	57%	2%
Mandi	33%	12%	0%	11%	44%
Shimla	83%	6%	0%	12%	0%
Sirmaur	47%	1%	0%	52%	0%
Solan	85%	0%	0%	15%	0%
Una	81%	11%	0%	6%	2%

2475 year return period earthquake may cause full / partial collapse of more than 50% of building stock in Hamirpur, Kangra, Kullu, Lahul & Spiti, Mandi and Sirmaur (Table 39). More than 25 to 40% buildings will suffer D2 and D3 category of damage in all the districts.

Table 39: Percentage of Building Damage due to Earthquake of 2475 year return period

District	D1	D2	D3	D4	D5
Bilaspur	39%	17%	10%	0%	33%
Chamba	22%	19%	25%	0%	34%
Hamirpur	0%	4%	14%	26%	55%
Kangra	13%	21%	12%	8%	46%
Kinnaur	45%	31%	21%	0%	3%
Kullu	11%	18%	11%	0%	60%
Lahaul & spiti	3%	34%	4%	0%	59%
Mandi	14%	6%	14%	11%	55%
Shimla	52%	31%	6%	0%	12%
Sirmaur	0%	47%	1%	0%	52%

Solan	22%	62%	1%	0%	15%
Una	67%	14%	0%	7%	12%

Table 40: Percentage of Buildings Falling under Different Damage Category for Earthquake of 475 Return Period

Building Typology	D1	D2	D3	D4	D5
Brick Masonry	84%	13%	2%	1%	0%
Stone Masonry	47%	0%	0%	15%	37%
Rammed Earth	0%	5%	6%	88%	1%
RC Frame	64%	32%	5%	0%	0%
Hybrid & Others	44%	56%	0%	0%	0%

Table 40 shows the percentage of damaged buildings of all five predominant building typology of Himachal Pradesh in different category of damage grade for 475 year return period of earthquake. 475 year return period is the most commonly used earthquake level for estimating the maximum probable loss. It is expected that most of the stone masonry and rammed earth building will receive sever damage (D4 & D5) while RC frame and hybrid buildings will receive the partial (D1 & D2) to moderate damage (D3). Stone masonry buildings constitute huge vulnerable building stock as they are mostly laid irregularly over each other and there is no interlocking between each other.

As brick masonry buildings are the maximum in numbers, even 3% building suffering D3 and D4 category of damage means more than 14000 buildings have to be vacated and almost 63000 people have to be relocated. Hybrid buildings are expected to perform better where traditional building practices are adopted like Kath Kunni, Dhajji Dewari and Thatara. Others buildings include where wall material is used as thatch, bamboo, polythene, GI sheet etc. They are light in weight and have more flexibility to sustain the excessive lateral forces during seismic activity hence they will suffer less damage in comparison to brick or stone masonry buildings.

Figure 100 represents the expected damage in stone masonry building due to earthquake of 475 year return period. For mapping, building damage is categorized into four types i.e. partially damaged (D1&D2), moderately damaged (D3), severely damaged (D4) and destroyed/ full collapse (D5). Areas highlighted in dark colors represent the higher number of buildings in comparison to other areas. D4 category of damage occurs mostly in Chamba, Kangra, Kullu and Sirmaur. D5 category of damage mostly occur in Kangra, Chamba, Madi, Hamirpur and Kullu. Maps showing the damage of other building typologies in earthquakes of different return periods are shown in Annexure 7.

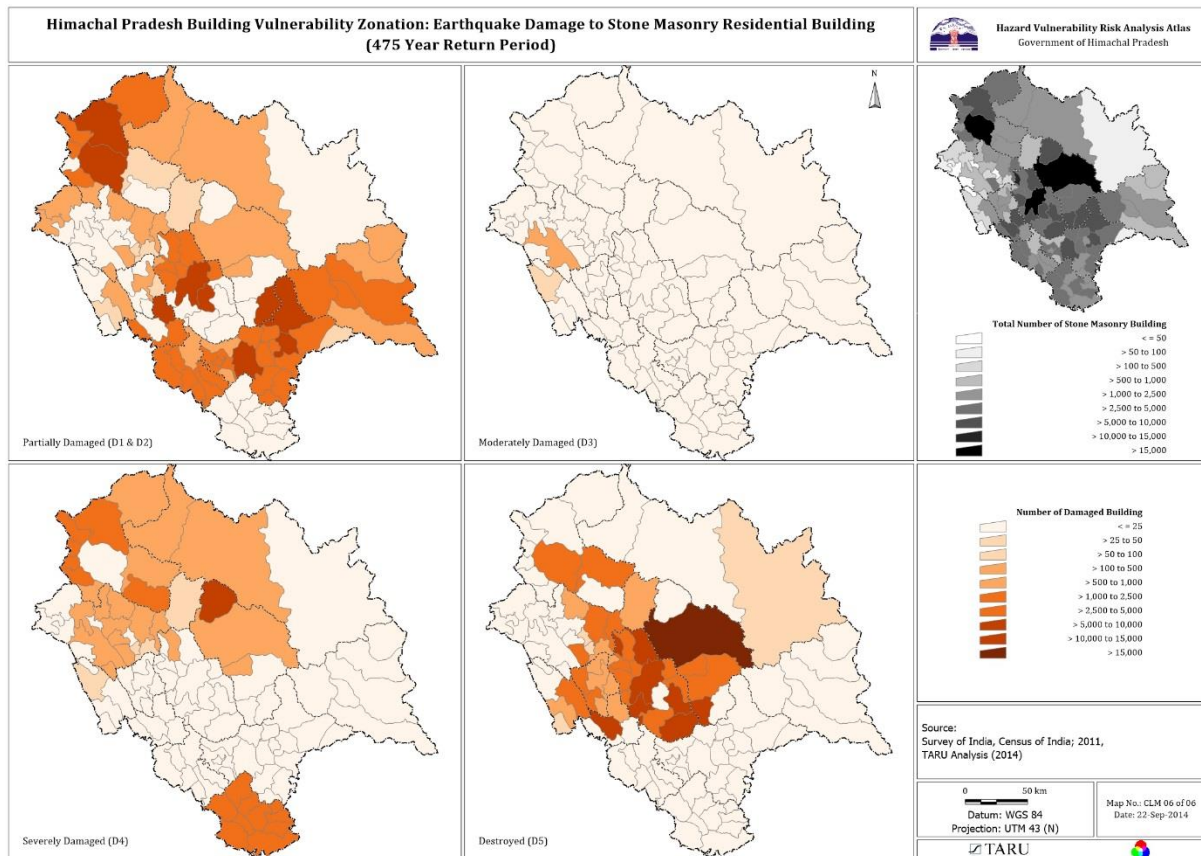

Figure 100: Earthquake Damage to Stone Masonry Residential Building (475 years Return Period)

As per IS 1893:2002, seismic zone map of India divides the Himachal Pradesh into zone IV (MSK intensity of VIII) and zone V (MSK intensity of IX or more). The assigned peak ground acceleration in seismic zone IV and zone V are 0.24g and 0.36g respectively. These PGA values for zone IV and V are used to estimate the lateral forces for which structure has to be designed and they should not be used for micro zonation studies (Agrawal & Chawla, 2006). Building damage estimate has also been computed for PGA=0.24g i.e. earthquake of MSK intensity of VIII and PGA=0.36g i.e. earthquake of MSK intensity IX or more. It is expected that all rammed earth buildings may collapse or suffer severe damage in these scenarios. Stone masonry buildings will also receive more than 50% damage of D4 and D5 category (Table 41.)

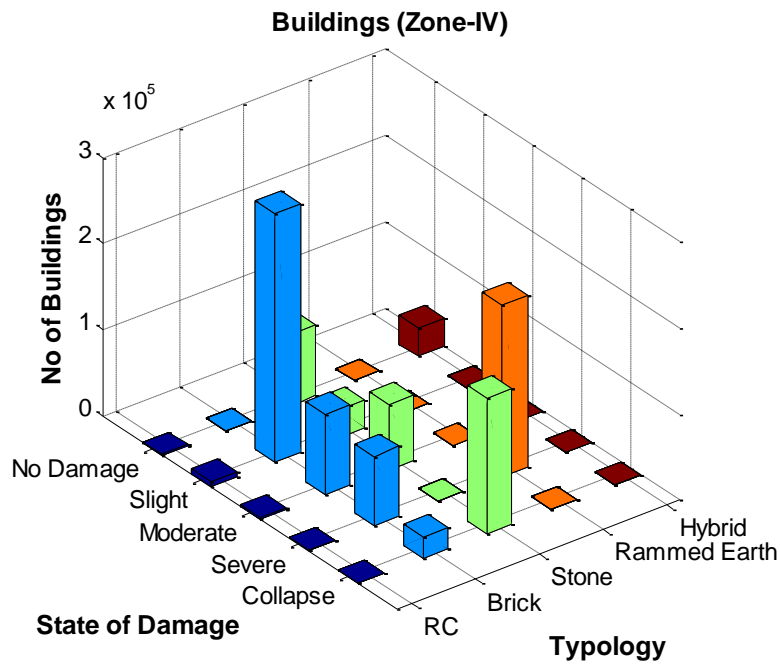

Figure 101: Damage state of all type of buildings of HP subjected to 0.24 g

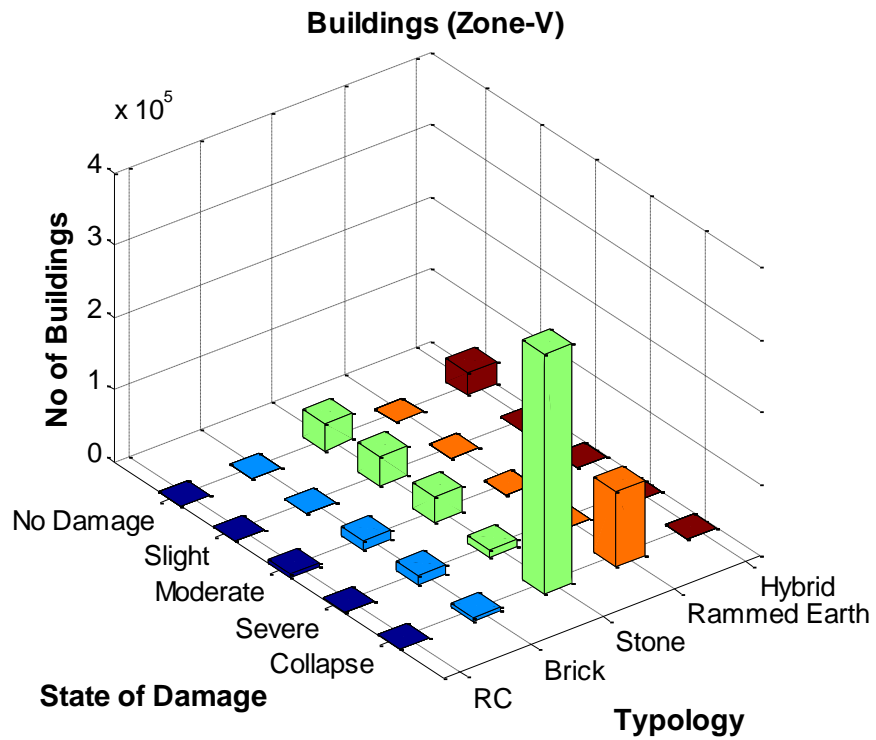

Figure 102: Damage state of all type of buildings of HP subjected to 0.36 g

Table 41: Proportion of damage of buildings in the state of HP for MSK VIII or seismic zone IV

Building Type	No damage (D1)	Slight damage (D2)	Moderate damage (D3)	Severe damage (D4)	Collapse (D5)
Reinforced Concrete	1.7%	72.9%	17.2%	8.0%	0.16%
Brick Masonry	0%	79%	11.2%	8.8%	1%
Stone Masonry	25%	7.7%	15.6%	0%	51.7%
Rammed Earth	0%	0%	0%	100%	0%
Hybrid	100%	0%	0%	0%	0%

Table 42: Proportion of damage of buildings in the state of HP for MSK IX or seismic zone V

Building Type	No damage (D1)	Slight damage (D2)	Moderate damage (D3)	Severe damage (D4)	Collapse (D5)
Reinforced Concrete	0%	3.6%	80%	7.6%	8.8%
Brick Masonry	0%	4.0%	55.8%	33.8%	6.4%
Stone Masonry	14%	11.8%	7.4%	1.4%	65.4%
Rammed Earth	0%	0%	0%	0%	100%
Hybrid	100%	0%	0%	0%	0%

Figures 101 and 102 shows the level of damage for PGA 0.24g and 0.36g at district level. It can be observed that RC frame building will be severely damaged in Bilaspur, Lahul & Spiti and Kinnaur. An earthquake of MSK intensity IX will moderately damage (40 to 60% damage) in most of the RC frame buildings in almost all the district.

A large number of brick masonry buildings will get D4 and D5 category of damage in Chamba, Kullu, Mandi and Shimla. This figure reveals the fact that large number of brick masonry buildings were constructed in non-engineered fashion to fulfil the rising housing needs in these district but quality of construction was not maintained which resulted into high vulnerability of building stock. Figure 103 to 107 represent the graphical comparison between damage caused in the different type of buildings due to earthquake generating peak ground acceleration of 0.24g and 0.36 g.

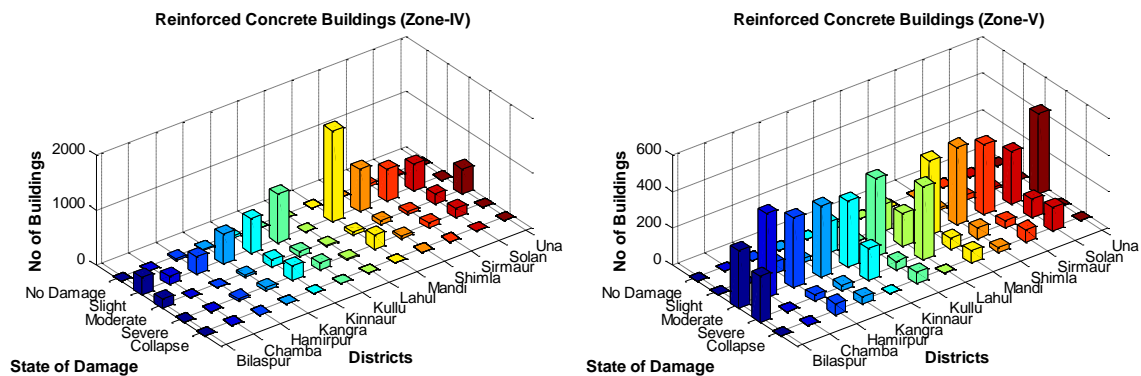

Figure 103: Damage state of RC buildings in all districts of HP subjected to 0.24 g & 0.36g

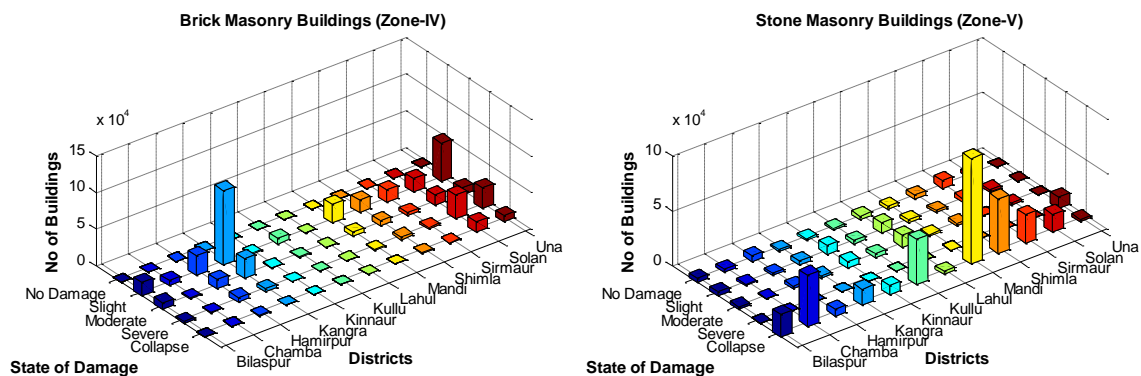

Figure 104: Damage state of brick masonry buildings in all districts of HP subjected to 0.24 g & 0.36g

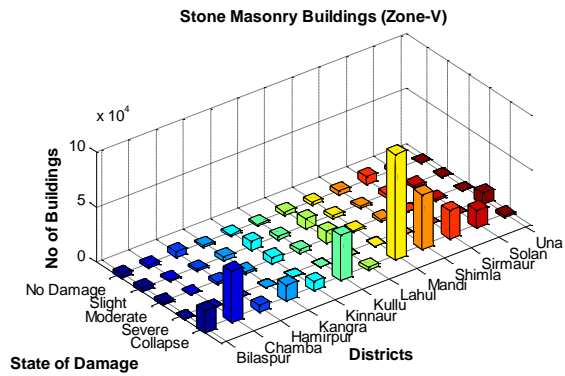
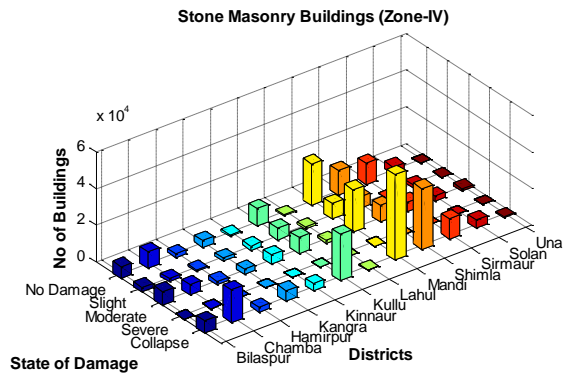

Figure 105: Damage state of stone masonry buildings in all districts of HP subjected to 0.24 g & 0.36g

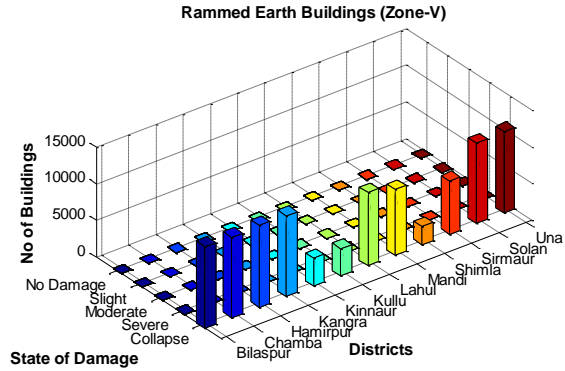
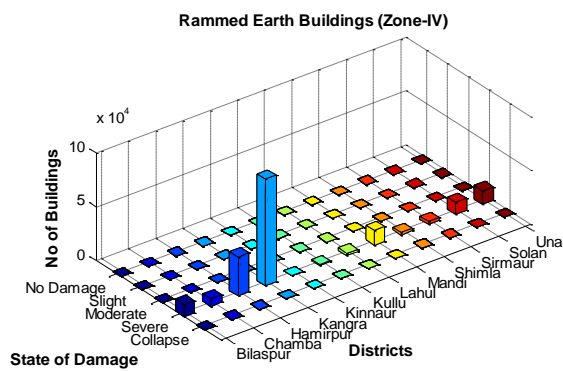

Figure 106: Damage state of rammed earth buildings in all districts of HP subjected to 0.24 g & 0.36g

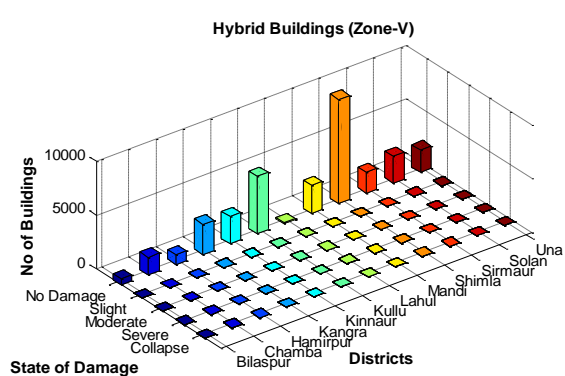
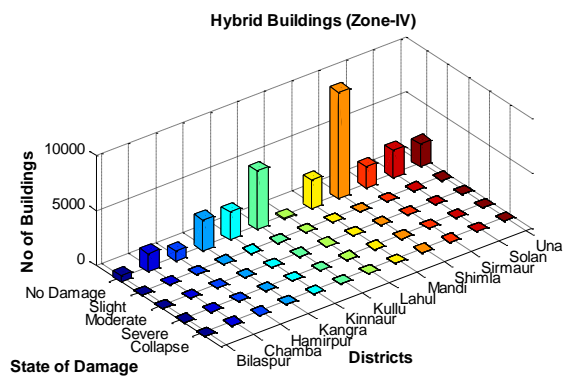

Figure 107: Damage state of hybrid buildings in all districts of HP subjected to 0.24 g & 0.36g

9.6. Life Loss Estimation due to Earthquake:

Estimation of potential loss of lives is calculated using for different intensity of earthquake for different time scenario of the earthquake event. Number of expected casualties is calculated for both mid night and day time scenario as the population

under risk will be higher at night time in comparison to day time when most of the people are awake and they have the possibility to come out of the buildings to an open space. Table 43 provides the details of number of casualties due to earthquake only for the duration of 1900-2014. Out of 27 events in that duration, 2 major earthquake event (Kangra 1905 & Bhuj 2001) took more than 35,000 lives alone.

Table 43: Summary of Earthquake Loss in India from 1900 to 2014

Summary of Earthquake Loss in India from 1900 to 2014 (Source: EM-DAT)			
No. of Events	No. of Deaths	No. of Affected	Total Damage (in million USD)
27	61,820	27,899,733	4,199,900
Average per event	2,290	1,033,323	1,55,552

Source: EM-DAT

There are several methods to estimate the human casualties. It may be classified into two categories: one estimate the number of casualties from the number of collapsed/severely damaged houses (Ohta et al., 1983) and one consider various causes and estimated casualties for each cause (Yamazaki et al., 1996). Second method is more useful when life loss estimation has to be computed for earthquake induced other hazards also like fire, landslide etc. and other factors like shock, trauma, poor medical facility in the affected area.

In preparing HVRA atlas for Gujarat, TARU took a different methodology to arrive at the casualty estimation due to earthquake. Due to lack of data about vulnerability of current building stock, casualty estimation was done based on the available data of historical earthquakes. Trends in past earthquake casualties in different region of India across various earthquake magnitude experienced in last years has been taken as reference after normalizing the population growth. Relations were established between number of deaths/ 1000 person and PGA range & type of building typology to compute the expected casualties.

Here estimation of deaths due to earthquake has been carried out by taking the advantage of both past data of major earthquake (Kangra 1905) of Himachal Pradesh and building vulnerability assessment of current building stock of the state. For estimating the potential loss of lives, family size per house is assumed as 4.5. Kangra earthquake of magnitude 8.0 occurred at 6.20 AM. In Kangra and Palampur Tehsils above 13000 persons got killed which was about 1/10th of the population of these tehsils (Arya, 1992). It is assumed that most of the people will be out for work in day time and hence death rate in fully collapsed houses is assumed as 10% only while for partially collapsed houses, it may be assumed as 5%. For mid night scenario, death rate is taken as 40% and 20% for fully collapsed and partially collapsed houses respectively (Arya 1992).

Table 44: Assumed Death Rates for Earthquake

Time of Occurrence	Deaths in Collapsed Houses	Deaths in Partially Collapsed
--------------------	----------------------------	-------------------------------

		Houses
Midnight (Sleeping)	40%	20%
Daytime (working)	10%	5%

(Source: Arya 1992)

As building damage was calculated for entire building stock of the state, expected number of casualties were calculated for current density of buildings and population. It is assumed that loss of life will occur only in those buildings which will suffer D4 & D5 category of damage.

Tables 45 represents the estimated number of deaths from earthquake for midnight scenario under different return period of earthquake. It has to be noted that these are the maximum number of casualties that can occur in a district if maximum expected PGA is achieved in the area. This cannot occur in reality as intensity of earthquake varies with the distance from epicenter and hence PGA at remote sites might be less than the maximum expected one.

100 and 200 year return period earthquake will cause most of damage in D1, D2, D3 category and hence number of expected casualties are less. But a massive earthquake of return period 475 year or 2475 year can increase the toll in the state as much 6 to 10 lakhs. In Hamirpur, Kangra, Kullu, Mandi and Sirmaur, maximum death toll will vary between 1 to 3 lakhs if earthquake of MSK intensity IX or more strike. These death estimates are the maximum in a location and they should not be seen as the cumulative one as earthquake of an equal intensity cannot occur at all location in reality.

Table 45: Estimated Number of Deaths from Earthquake: Mid Night Scenario

Estimated Number of Deaths from Earthquake: Mid Night Scenario				
District	100 year return period	200 year return period	475 year return period	2475 year return period
Bilaspur	0	325	30642	42279
Chamba	120	3633	34592	58976
Hamirpur	3629	9325	54269	122421
Kangra	0	951	125151	301721
Kinnaur	0	0	431	862
Kullu	0	0	95050	105310
Lahaul & Spiti	0	1	3304	6371
Mandi	351	55949	198139	240898
Shimla	0	0	10227	20466
Sirmaur	0	0	46839	94058
Solan	0	0	10753	21502
Una	0	804	11538	29551

Source: TARU Analysis 2014

Figure 108 represent the distribution of number of casualty at tehsil level. Most of the casualties occur in the region of Kullu, Kangra, Mandi and Hamirpur. Number of casualties are found less in tehsils like Pangi, Udaipur, Lahul and Rohru due to very less population but casualty ratio may be high due to partial or full collapse of stone buildings.

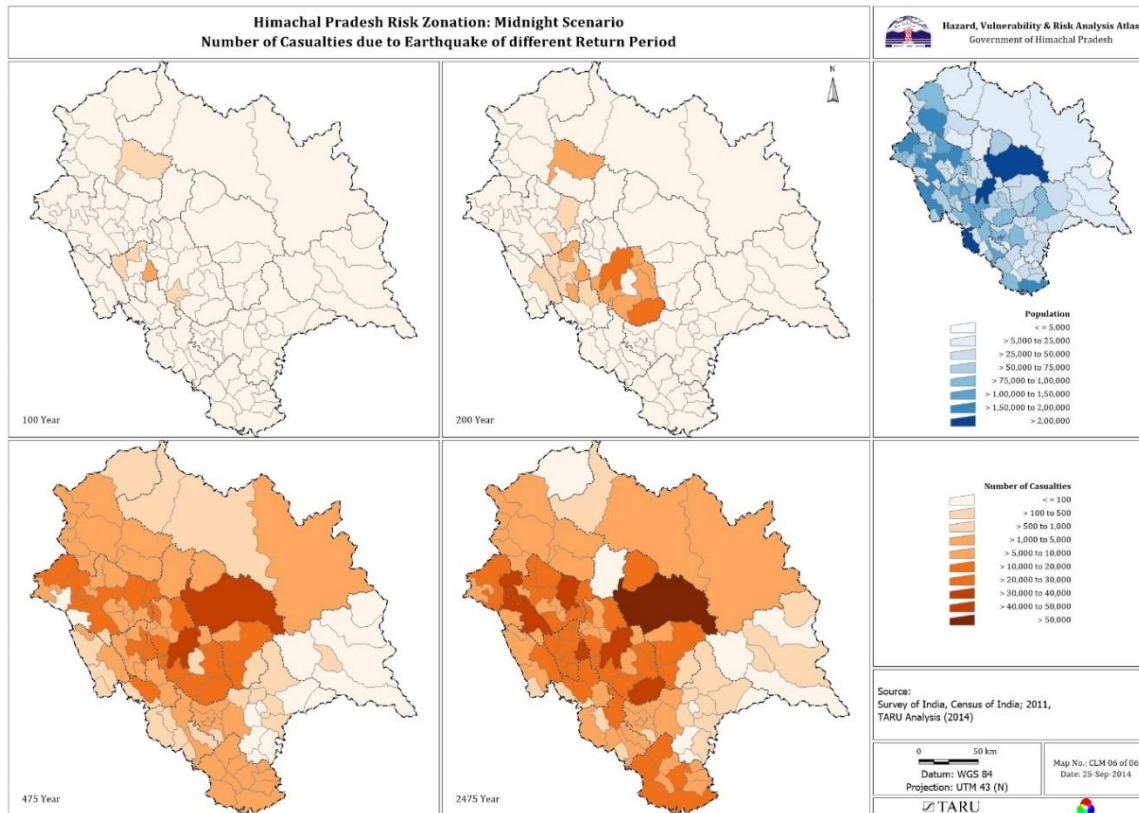

Figure 108: Number of Casualties due to Earthquake of different Return Period (Midnight Scenario)

In daytime earthquake event, it is expected that people will get the chance to come out of the building as they are not sleeping. Expected number of casualties in the state may vary from 1.5 lakhs to 2.6 lakhs during day time. Figure 109 represent the casualty distribution in daytime scenario.

Table 46: Estimated Number of Deaths from Earthquake: DayTime Scenario

Estimated Number of Deaths from Earthquake: DayTime Scenario				
District	100 year return period	200 year return period	475 year return period	2475 year return period
Bilaspur	0	81	7660	10570
Chamba	30	908	8649	14744
Hamirpur	908	2330	13566	30605
Kangra	0	238	31288	75428
Kinnaur	0	0	107	217
Kullu	0	0	23764	26328
Lahaul &	0	0	826	1593

Spiti				
Mandi	88	13987	49536	60224
Shimla	0	0	2557	5116
Sirmaur	0	0	11711	23515
Solan	0	0	2689	5376
Una	0	201	2884	7388

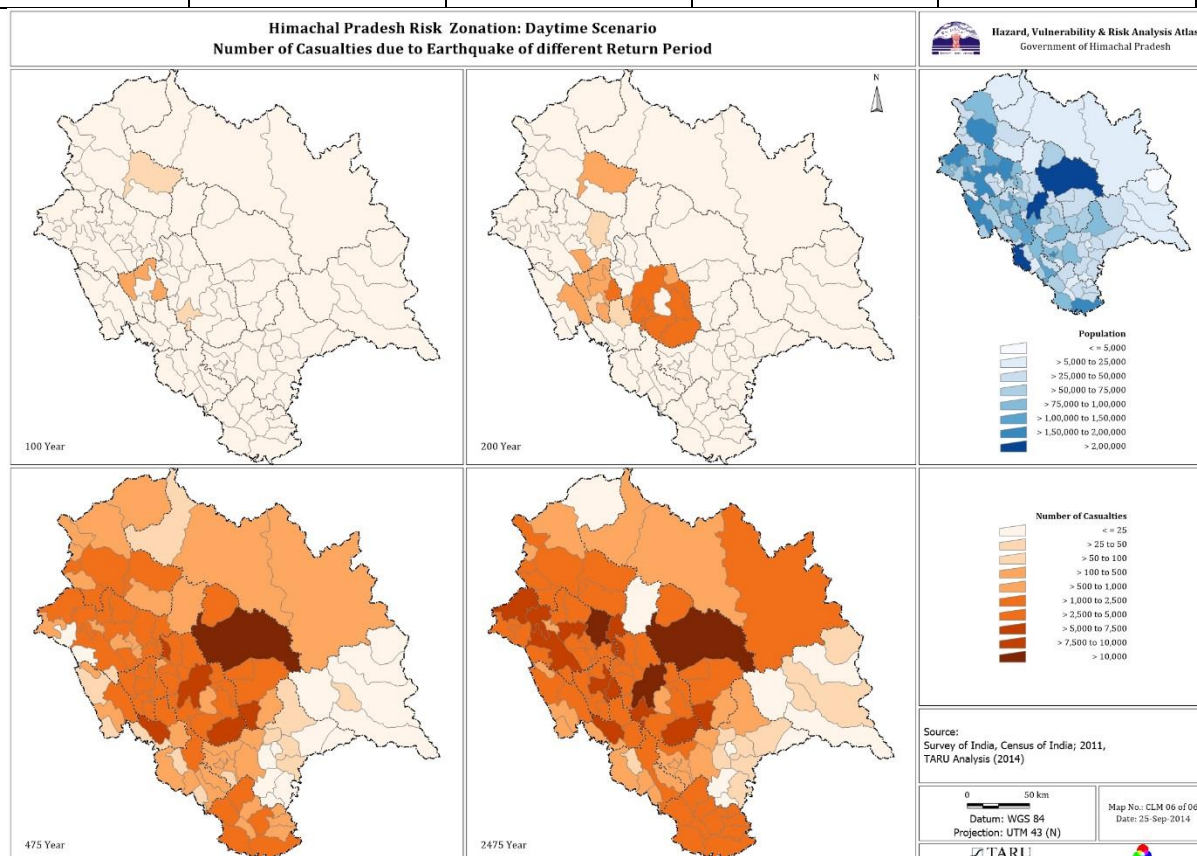

Figure 109: Number of Casualties due to Earthquake of different return period (Daytime Scenario)

9.7 Economic Loss Estimation due to Building Damage:

Economic losses due to earthquake in terms of building damage was estimated for 100 year, 200 year, 475 year and 2475 year return period. Statistical analysis was carried out on surveyed building data to calculate the average built up area for a particular building typology. Unit cost of construction in INR per square meter is calculated for 16 building type of different roof wall combination (Table 47). Brick masonry structure with slate and GI roofing is more costly than concrete roofing due to the additional requirement of understructure. Cost of RC frame building was found approximately INR 8000-9000 per square meter depending upon the type of roofing material provided either concrete or GI sheet.

Table 47: Average built up area and Cost of Building per square meter

Building Type (wall & roof)	Area (square meter)	Unit Cost (INR)	Cost of Building per square meter (INR per square meter)
Burnt Brick & Concrete	84	313600	3751

Building Type (wall & roof)	Area (square meter)	Unit Cost (INR)	Cost of Building per square meter (INR per square meter)
Burnt Brick & GI sheet	47	258336	5539
Burnt & Stone/Slate	68	280338	4105
Stone with mortar and stone/ slate	65	189930	2921
Stone with mortar and GI sheet	80	322784	4040
Stone with mortar and concrete	70	200532	2878
Stone with mortar & Grass/thatch	27	76182	2847
Stone without mortar and Stone/ Slate	55	157038	2875
Stone without mortar & GI sheet	49	178397	3640
Stone without mortar & Concrete	67	164399	2458
Stone without mortar & Grass/thatch	23	56248	2422
Mud & Stone/Slate	54	77571	1450
Mud & GI sheet	39	95921	2482
Mud & Grass thatch	18	13604	763
BB & C (RC Frame)	88	782770	8916
BB & GI sheet (RC Frame)	106	780176	7405

Sample of 9099 buildings was used to arrive the number of damaged buildings (classified in terms of number of storey) under each category of damage (D1 to D5). It was found that cost of foundation varies for different type of building typology. Foundation cost vary from 20 to 30% of total cost of the building (TARU Analysis 2014). Suitable reduction factor in the total cost of building was applied for multistoried building as multistoried buildings will add more some extra expenditure for the foundation but not multiple of number of stories to the foundation cost of single storey building.

Damage factor of 0.05, 0.2, 0.4, 0.6, 0.8 are assumed for the damage category of D1, D2, D3, D4 and D5. Earthquake loss to a building is computed as

$$\text{Loss} = \text{Factor for Multistoried building} * \text{average area} * \text{cost of building (INR per sq.m.)} * D_i$$

Where D_i is the damage factor as mentioned above.

Figure 110 represents the economic loss due to damage of buildings in earthquake of different return period. It can be observed from the map that there is not so significant difference in total estimated loss in most of the tehsils during 100 and 200 year return period earthquake but 475 year return period earthquake can increase the heavy economic loss due to severe damage of

building stock. Kullu, Mandi and Kangra will cause a huge impact on their economy due to large number of buildings getting severely damaged.

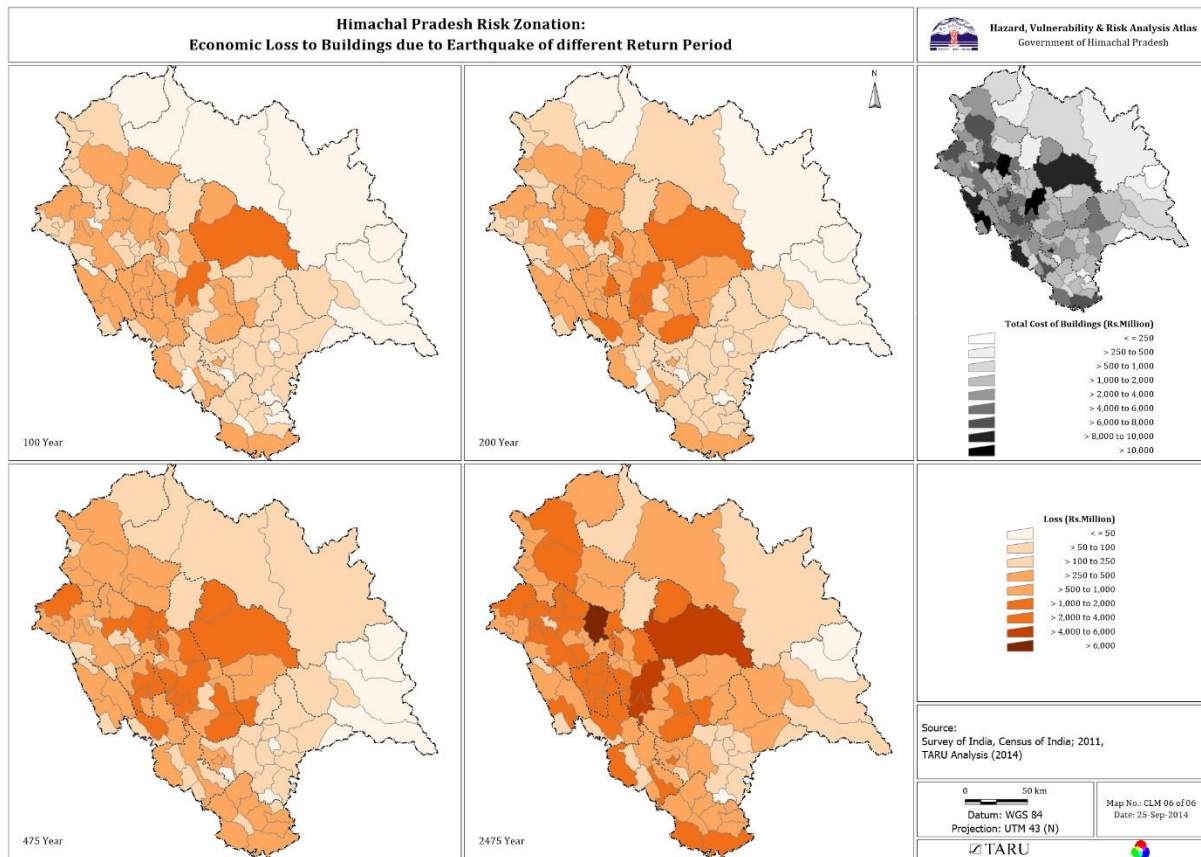

Figure 110: Economic Loss to Buildings due to Earthquake of different Return Period

10. CONCLUSIONS AND RECOMMENDATIONS:

- Building vulnerability assessment in the state of Himachal Pradesh shows that stone masonry and rammed earth building types are the most vulnerable one which may cause the huge loss of life in the state.
- In last two decades brick masonry and RC frame construction have been on rise but the quality of construction was not maintained which resulted into increasing vulnerability.
- For 475 year return period of earthquake, 52% stone masonry buildings and 89% rammed earth buildings may suffer severe damage while only 1% brick masonry will suffer D4 & D5 category of damage.
- 100 and 200 year return period earthquakes will cause mostly economic damage and less number of casualties. 475 and 2475 year return period earthquakes will cause maximum casualties in Kangra, Mandi, Kullu and Hamirpur.
- Increase of one level of earthquake intensity (from VIII to IX) will cause 30% increase in the numbers of stone masonry buildings affected severely while 2 to 3 times more brick masonry building will suffer severe damage.
- Educational institute and health facilities which are constructed in last two decades are more vulnerable in comparison to old structures. Retrofitting of critical buildings like schools and hospitals should be the taken on priority.

- Vulnerability assessment of cowsheds found them highly vulnerable to severe damage due to absence of mud or no mortar used as binding material for wall constructions. Conditions of cowsheds has to be improved by introducing light and flexible structures so that livelihood can be protected during earthquake.
- Lack of knowledge about earthquake safety features in building construction increase the vulnerability of newly built structures also.
- Traditional construction practices like Dhajji Dewari and Kath Khunni should be promoted as these structures have shown great capability to resist the lateral forces during strong earthquake also.
- Most of the buildings are non-engineered construction. A lot of alteration occur without approval from concerned authorities which make them more vulnerable. It is recommended to develop the web based decision support system to check the vulnerability of building before permitting the further addition of floor on already existing buildings.
- Inventory of building typology should be updated atleast in every decade to get more information on the existing building stock so that risk estimate can be updated more precisely.
- Vulnerability and damage assessment of buildings represent the areas having concentration of risk at certain areas. Mitigation planning should be taken at tehsil and district level to improve the building condition.

11. REFERENCES:

- Mehrain, M. and Naeim, F. (2004), Rammed earth house in Iran, Earthquake Engineering Research Institute (EERI) and International Association for Earthquake Engineering (IAEE).
- Ömer Aydan (2008), A Reconnaissance Report on 2008 Wenchuan Earthquake Japan Society of Civil Engineers.
- Keefe, L. (2005). Earth building: Methods and materials, repair and conservation, Taylor and Francis, Oxon.
- Minke, G. (2006). Building with earth: Design and technology of a sustainable architecture, Birkhäuser, Basel.
- Bui T.T, Bui Q.B, Limam A, Maximilien S., (2014), Failure of rammed earth walls: from observations to quantification Construction and Building Materials, 295-302
- Maria G, Mário L. B, Jorge B., (2011), Seismic resistance of earth construction in Portugal, Engineering Structures 33, 932–941.
- Vishwa B. Chandel S and Karanjot K.B., (2010), Seismicity and vulnerability in Himalayas: the case of Himachal Pradesh, India, Geomatics, Natural Hazards and Risk Vol. 1, No. 1, 69–84.
- Dowling, D. 2004a, 'Horizontal Shear Testing of Mudbrick Masonry Mortar Joints', paper presented to the Proceedings of 7th Australasian Masonry Conference Newcastle, Australia.
- Blondet, M., Brzev, S. 2003, Earthquake-Resistant Construction of Rammed earth Buildings: A Tutorial, EERI/IAEE World Housing Encyclopaedia.
- Smith, K. 2001, Environmental hazards, 3rd edn, Routledge, New York, USA.
- Christie, J. 1990, 'Improving the seismic resistance of earth buildings', Earth building for the '90s, Ph.D Thesis, University of Auckland, university of Auckland.
- Wojciechowska, P. 1967, Building with Earth: a guide to flexible-form earthbag construction, Chelsea Green, U.S.A.
- Houben, H. and Guillaud, H. 1994, Earth Construction-A Comprehensive Guide, ITDG Publishing, London, UK.
- Tagel-Din H, (1998), A New Efficient Method for Nonlinear, Large Deformation and Collapse Analysis of Structures, Ph.D Thesis, Civil Engg. Dept., University of Tokyo, September, 1998.

Tagel-Din H and Kimiro M., Applied Element Method for Simulation of Nonlinear Materials: Theory and Application for RC Structures, Structural Eng./Earthquake Eng., JSCE, Vol 17, No.2, 2000.

N.R.Vineetha, Arun Menon, Ravindra Gettu, Seismic Response of Hybrid Buildings, Proc. Of the 15th World conference on earthquake engineering LISBOA: 2012.

H.A.Meireles, R.Bento, S.Cattari, S.Lagomarsino, Seismic assessment and retrofitting of pombalino buildings by fragility curves, Proc.of the 15th World conference on earthquake engineering LISBOA: 2012

Graca Vasconcelos, Elisa Poletti, Eunice Salavessa, Abilio M.P.Jesus, Paulo B.Lourenco, Preecha Pilano, In-plane shear behavior of traditional timber walls. J Struct Eng 56 (2013):1028-1048.

F. Vieux-champagne, Y.Siefert, S.Gränge, A.Polastri, A.Ceccotti, L.Daudeville, Experimental analysis of seismic resistance of timber-framed structures with stones and earth infill. J struct Eng 69 (2014):102-115

Jurukovski, D, Kretevska, L, Alessi A, Diotallevi, P.P., Merli, M. and Zarri, F. (1992), Shaking table test of three four-storey brick masonry models: Original and strengthened by RC core and by RC jackets, Proc. 10th World Conference on Earthquake Engineering, Balkema, Rotterdam, pp 2795-2800.

Cattari, S. and Lagomarsino, S.(2006), Nonlinear analysis of mixed masonry and reinforced concrete buildings, 1st European Conference on Earthquake Engineering and Seismology, Geneva, Switzerland, Paper no 927.

Bose, P.R, Sinval, A., Bose, A., Verma, A. and Khan, A.A. (2004), Implications of design and construction decisions on earthquake damage of masonry buildings, 13th World Conference on Earthquake Engineering, Vancouver, B.C., Canada, Paper No. 2563.

Bothara, J.K., Parajuli, Y.K., Arya, A.S. and Sharpe, R.D.(2000), Seismic Safety in Owner -Built Buildings, 12th World Conference in Earthquake Engineering, Auckland, New Zealand, Paper No. 2130.

Modena, C., La Mendola, P. and Terrusi, A. (1992), Shaking table study of a reinforced masonry building model, Proc. 10th World Conference on Earthquake Engineering, Balkema, Rotterdam, pp. 3523-3526.

Lang, K. and Bachmann, H. (2004), on the seismic vulnerability of existing buildings: A case study of the city of Basel, *Earthquake Spectra*, Vol. 20 (1), pp. 43-66.

Magenes, G. and Penna, A. (2009), Existing masonry buildings: General code issues and methods of analysis and assessment, *Eurocode & Perspectives from the Italian Standpoint Workshop*, pp. 185-198.

Valluzzi, M.R, Cardani, G., Binda, L. and Modena, C. (2004), Seismic vulnerability methods for masonry buildings in historical centres: validation and applications for prediction analysis and intervention proposals”, *13th World Conference on Earthquake Engineering*, Vancouver, B.C., Canada, Paper No. 2765.

Lagomarsino, S., Penna, A. and Galasco, A., TREMURI: Seismic Analysis Program for 3D Masonry Buildings, University of Genoa, 2006.

Magenes, G., Remino, M., Manzini, C., Morandi, P. and Bolognini, D., SAM II, Software for the Simplified Seismic Analysis of Masonry buildings, University of Pavia and EUCENTRE, 2006.

Lagomarsino S. And Giovinazzi S., (2006), Macro seismic and mechanical models for the vulnerability and damage assessment of current buildings, *Bulletin of Earthquake Engineering*.

R. Senthivel, P.B. Lourenco and G. Vasconcelos. (2006) “Analytical Modeling of Dry Stone Masonry Wall Under Monotonic and Reversed Cyclic Loading”, University of Minho, Department of Civil Engineering, Guimarães, Portugal.

K S Jagadish, S Raghunathand K S Nanjunda Rao, “Behaviour of masonry structures during the Bhuj earthquake of January 2001”.

Matthew J. DeJong. (2009) PhD thesis on “Seismic Assessment Strategies for Masonry Structures, Massachusetts Institute of Technology”.

Jitendra Bothara,Svetlana Brzev.(2011) “A Tutorial: Improving the Seismic Performance of Stone Masonry Buildings”.

M. Rota, A. Penna and G. Magenes.(2008) “A Procedure for Deriving Analytical Fragility Curves forMasonry Buildings”, The 14th World Conference on Earthquake Engineering , Beijing, China.

Ahmad Abo-El-Ezz, Marie-José Nollet, Miroslav Nastev, “Analytical Displacement-Based Seismic Fragility Analysisof Stone Masonry Buildings”, Department of Construction Engineering, École de technologie supérieure, University of Québec, Montréal, Canada.

Amin Karbassi and Pierino Lestuzzi, (2012) “Fragility Analysis of Existing Unreinforced Masonry Buildings through a Numerical-based Methodology”, *The Open Civil Engineering Journal*.

Thomas M. Frankie, S.M.ASCE¹; Bora Gencturk, A.M.ASCE²; and Amr S. Elnashai, F.ASCE³, (2013)“Simulation-Based Fragility Relationships for Unreinforced Masonry Buildings”.

IS 1893: Part 1: 2002 (2007). Criteria for Earthquake Resistant Design of Structures - Part 1:General Provisions and Buildings, Bureau of Indian Standards, New Delhi.

IS 13828: 1993 (2008), Improving earthquake resistance of low strength masonry buildings – Guidelines, Bureau of Indian Standards, New Delhi.

IS 4326: 1993 (2008) Code of practice for earthquake resistant design and construction of buildings, Bureau of Indian Standards, New Delhi.

IS 13920:1993 (2008), Ductile detailing of reinforced concrete structures subjected to seismic forces - Code of practice, Bureau of Indian Standards, New Delhi.

Srikanth T., Kumar R. P., Singh, A. P., Rastogi, B.and Kumar, S. (2010) “Earthquake Vulnerability Assessment of Existing Buildings in Gandhidham and Adipur Cities Kachchh, Gujarat (India)”.

Shunsuke Otani “Seismic vulnerability assessment methods for Buildings in Japan” , Earthquake Engineering and Engineering seismology, Volume 2, Number 2, September 2000, pp.47-56.

Rahman Md Aftabur, Ullah Md Shajib “Seismic Vulnerability Assessment of RC Structures: A Review”, Int. J Sci. Emerging Tech, Vol-4 No 4 October 2012.

Prathibha S, A Meher Prasad “Seismic Vulnerability Assessment of Existing buildings in India”, 13WCEE,Vancouver, B.C., Canada ,August 1-6, 2004 ,Paper No. 1207.

Watcharin Jinwuth, A study into the earthquake resistance of circular adobebuildings, Ph.D Thesis, Department of Architecture and Building, University Technology of Sydney, 2012.

ANNEXURE 1: TEAM FOR BUILDING VULNERABILITY ASSESSMENT

Organization/ Institutions	Name	Address	Contact Details
TARU Leading Edge Pvt. Ltd.	Shashank Mishra	424 Qutab Plaza DLF City Phase-1 Gurgaon-122002, India.	E-mail: smishra@taru.org Ph: +91-124-2560 424/ 421 Mobile:+91- 8130749367
	Navneet Yadav	424 Qutab Plaza DLF City Phase-1 Gurgaon-122002, India.	E mail: nyadav@taru.org Mobile: +91-9816678898
	Piyush Shah	541/2, Sector-8 Gandhinagar-382008 Gujarat, India.	E mail: pshah@taru.org Ph: 91-79-23240479 Mobile: +91-9408721451
	Anup Karanth	424 Qutab Plaza DLF City Phase-1 Gurgaon-122002, India.	E-mail: akaranth@taru.org Ph: +91-124-2560 424/ 421 Mobile: +91-9818060343
	Dr.Umamaheshwaran Rajasekar	424 Qutab Plaza DLF City Phase-1 Gurgaon-122002, India.	E-mail: mrjasekar@taru.org Ph: +91-124-2560 424/ 421 Mobile: +91- 09724871091
NIT Hamirpur	Dr. Hemant Kumar Vinayak, Assistant Professor	Department of Civil Engineering National Institute of Technology Hamirpur - 177 005 Himachal Pradesh, India.	E-mail: hemant.vinayak@gmail.com Ph: +91-1972- 304346 Mobile: +91-9418075886
EERC, IIIT Hyderabad	Prof. Ramancharla Pradeep Kumar, PhD, Associate Professor & Head	Earthquake Engineering Research Centre International Institute of Information Technology (IIIT) Gachibowli, Hyderabad 500 032	Ph: 040 6653 1187, Fax: 040 6653 1413 Mobile: 093911 31199, E-mail: Ramancharla@iiit.ac.in

Organization/ Institutions	Name	Address	Contact Details
	Dr Katta Venkataramana, Dr.Engg. Professor of Civil Engineering	National Institute of Technology Karnataka (NITK) Surathkal, Srinivasnagar Post 575 025 Mangalore, Karnataka	Tel: 0824-2474000 Extn. 3337 (office) Cell: 09448475875 Fax: 0824-2474033 Email: ven.nitk@gmail.com

ANNEXURE 2: LIST OF SURVEYORS

Name of the Surveyor	Institute	Area Covered
Shani Kumar	Govt. Polytechnic Banikhet, Chamba	Sundernagar, Rawalsar, Jogindernagar, Lahul, Kinnaur, Sirmaur, Una
Ankush Kumar	Govt. Polytechnic Banikhet, Chamba	Nagrota Bagwan, Bhawarna, Lahul, Kinnaur, Sirmaur, Una
Japinder Singh	Govt. Polytechnic Banikhet, Chamba	Chichyot, Seraj, Jogindernagar, Lahul
Anuj Dhiman	Govt. Polytechnic Banikhet, Chamba	Nurpur, Fatehpur
Abhishek Saklani	Govt. Polytechnic Banikhet, Chamba	Bilaspur, Kinnaur, Sirmaur, Una
Anil Kumar	Govt. Polytechnic Banikhet, Chamba	Bilaspur, Mandi, Sirmaur, Shimla, Solan
Ajay Kumar	Govt. Polytechnic Hamirpur	Bhoranj, Hamirpur
Anupam Kumar	Govt. Polytechnic Hamirpur	Nadaun, Paragpur, Jwalamukhi, Kullu, Chamba
Praveen Kumar	Govt. Polytechnic Hamirpur	Rawalsar, Mandi, Hamirpur
Sanjeev Sharma	Govt. Polytechnic Hamirpur	Sundernagar, Hamirpur
Abhishek		Kangra, Sirmaur
Arun Kumar	Govt. Polytechnic Hamirpur	Hamirpur, Dera Gopipur, Shimla, Kullu, Solan, Bilaspur, Chamba
Arun Kaundal	Govt. Polytechnic Hamirpur	Hamirpur, Dera Gopipur, Chamba
Lucky Jaswal	Govt. Polytechnic Hamirpur	Hamirpur, Nadaun, Paragpur, Jwalamukhi, Kullu, Shimla, Solan, Ghumarwin, Chamba
Rohit	MIT Hamirpur	Dharamsala, Yol, Kangra, Kullu, Shimla, Solan, Mandi
Sachin Kumar	Govt. Polytechnic Hamirpur	Hamirpur
Mukesh Kumar	Govt. Polytechnic Banikhet, Chamba	Kinnaur, Sirmaur, Kangra,
Sushil Kumar	MIT Hamirpur	Palampur, Tira Sujanpur, Jogindernagar, Kullu,
Shailender	MIT Hamirpur	Bajjnath, Bhawarna, Shimla, Solan, Kullu, Nurpur
Subhash Kumar	MIT Hamirpur	Chamba, Shimla, Solan, Nurpur
Narinder Singh	MIT Hamirpur	Kullu, Shimla, Solan
Arun Kumar Dadwal	MIT Hamirpur	Kullu, Shimla

ANNEXURE 3: DETAILS OF EERC, IIIT HYDERABAD TEAM FOR NDT

Team A

District Visited: Hamirpur, Kangra, Una

Name	Designation	Institution
Raju Sangem	Project Manger	EERC, IIIT Hyderabad
Narender B	Research Scholar	EERC, IIIT Hyderabad
Swajit Singh Goud	Research Scholar	EERC, IIIT Hyderabad
Gugan Vignesh	MS by research	EERC, IIIT Hyderabad
Shashank Mishra	Consultant	TARU

Team B

District Visited: Shimla, Mandi, Sirmaur

Name	Designation	Institution
Krishna Babu U	Technical Assistant	EERC, IIIT Hyderabad
Velani Pulkit D	MS by Research	EERC, IIIT Hyderabad
Ravi Kanth C	Research Scholar	EERC, IIIT Hyderabad
Ajay Kumar Sreerama	Research Scholar	EERC, IIIT Hyderabad
Navneet Yadav	Consultant	TARU

ANNEXURE 4: INTEGRATED RAPID VISUAL SCREENING FORMAT FOR BUILDINGS IN H.P.

Name of the Investigator/ Team:

Date:

1. General Information

<p>Front Picture of the Building</p> 	<p>Name of the Owner:</p> <p>Contact Number:</p> <p>Address:</p> <p>Block:</p> <p>District:</p> <p>Density:</p> <p>Urban <input type="checkbox"/> Rural <input type="checkbox"/></p> <p>No. of occupants in the building:</p> <p>Day: Night:</p> <p>Number of stories in the building:</p> <p>GPS Coordinate:</p>
<p>Side Picture of the Building</p> 	

Type of Use of the Building:

Residential			
Private Dwelling <input type="checkbox"/>	Flat <input type="checkbox"/>	Dormitories <input type="checkbox"/>	Hotels <input type="checkbox"/>
Educational			
Aanganwadi <input type="checkbox"/>	School <input type="checkbox"/>	College <input type="checkbox"/>	
Institutional			
Hospital <input type="checkbox"/>	Community health center <input type="checkbox"/>	Old age homes <input type="checkbox"/>	Orphanage <input type="checkbox"/>
Assembly			
Cinema Hall <input type="checkbox"/>	Town Hall <input type="checkbox"/>	Marriage Hall <input type="checkbox"/>	
Community Hall	Restaurant <input type="checkbox"/>	Court Complex <input type="checkbox"/>	
Important Government Buildings			

D.C. Office <input type="checkbox"/>	D.C. Resident <input type="checkbox"/>	Tourism Office <input type="checkbox"/>
PWD Offices <input type="checkbox"/>	HPSEB Offices <input type="checkbox"/>	HPIPH Offices <input type="checkbox"/>
Emergency Buildings		
Police Station <input type="checkbox"/>	Fire Station <input type="checkbox"/>	
Service Buildings		
Telecommunication and Substations <input type="checkbox"/>	Electric Sub stations <input type="checkbox"/>	Water Pump Stations <input type="checkbox"/>
Commercial		
Shop <input type="checkbox"/>	Supermarket <input type="checkbox"/>	Vegetable Market Building <input type="checkbox"/>
Cowsheds <input type="checkbox"/>		

2. Exposure to Hazard Types:

Geological	Hydro-meteorological	Others
Earthquake <input type="checkbox"/>	Riverine Flood <input type="checkbox"/> Cloud Burst <input type="checkbox"/>	Fire <input type="checkbox"/>
Landslide <input type="checkbox"/>	Wind Storm <input type="checkbox"/> Hail Storm <input type="checkbox"/>	Forest Fire <input type="checkbox"/>
	Avalanche <input type="checkbox"/> Flash Flood <input type="checkbox"/>	Lightning <input type="checkbox"/>
	Maximum height of the snow deposition:	

3. Site Characteristics:

a. Site Morphology:

Flat <input type="checkbox"/>	Crest <input type="checkbox"/>	Downward slope <input type="checkbox"/>	Trough <input type="checkbox"/>
-------------------------------	--------------------------------	---	---------------------------------

b. Soil :

Soil Type			Soil Nature		
Hard <input type="checkbox"/>	Medium <input type="checkbox"/>	Soft <input type="checkbox"/>	Expansive <input type="checkbox"/>	Non Expansive <input type="checkbox"/>	Unknown <input type="checkbox"/>
Parameters for Liquefaction potential of soil					
Depth of the water table (in ft)					
Whether the soil is sandy?			Yes <input type="checkbox"/>	No <input type="checkbox"/>	

4. Basic Details about Building:

4.1 Building Code compliance:

Engineered Building <input type="checkbox"/>	Non- engineered building <input type="checkbox"/>
--	---

4.2 Type of Construction:

Rammed Earth Stone Masonry Brick Masonry RC Frame
 Hybrid

4.3 Dimensions of the building (in ft.)

L	B	H

Building Element:

Beam	Material of the Beam			
	Wood	Masonry	Concrete	Steel
Minimum Size (in*in)	<input type="checkbox"/> <input type="checkbox"/> × <input type="checkbox"/> <input type="checkbox"/>	<input type="checkbox"/> <input type="checkbox"/> × <input type="checkbox"/> <input type="checkbox"/>	<input type="checkbox"/> <input type="checkbox"/> × <input type="checkbox"/> <input type="checkbox"/>	<input type="checkbox"/> <input type="checkbox"/> × <input type="checkbox"/> <input type="checkbox"/>

Column	Material of the Column			
	Wood	Masonry	Concrete	Steel
Minimum Size of rectangular section (in*in)	<input type="checkbox"/> <input type="checkbox"/> × <input type="checkbox"/> <input type="checkbox"/>	<input type="checkbox"/> <input type="checkbox"/> × <input type="checkbox"/> <input type="checkbox"/>	<input type="checkbox"/> <input type="checkbox"/> × <input type="checkbox"/> <input type="checkbox"/>	<input type="checkbox"/> <input type="checkbox"/> × <input type="checkbox"/> <input type="checkbox"/>
Minimum Size of circular section (diameter in inches)	<input type="checkbox"/> <input type="checkbox"/>	<input type="checkbox"/> <input type="checkbox"/>	<input type="checkbox"/> <input type="checkbox"/>	<input type="checkbox"/> <input type="checkbox"/>

4.4 Slope of the ground:

Building built on the slope	If yes/ Slope Angle
Yes <input type="checkbox"/>	Flat to Mild (0-15°) <input type="checkbox"/>
	Medium (15-30°) <input type="checkbox"/>
No <input type="checkbox"/>	Steep (>30°) <input type="checkbox"/>

4.5 Age, Area and cost of the building:

Age of Construction	Avg. Built up area (sq.ft.)	Cost of construction (in INR)

4.6 Foundation:

Type of Foundation	Isolated Footing <input type="checkbox"/>	Combined Footing <input type="checkbox"/>	Raft <input type="checkbox"/>	Pile <input type="checkbox"/>	Spread footing <input type="checkbox"/>	Mat <input type="checkbox"/>
Depth of Foundation (ft.)						



4.7 Floor details:

No. of floors supported on the slope	Is there a basement?	Predominant Material of the floor
None <input type="checkbox"/>	Yes <input type="checkbox"/>	Mud <input type="checkbox"/>
1 <input type="checkbox"/>	No <input type="checkbox"/>	Wood <input type="checkbox"/>
2 <input type="checkbox"/>	If yes, No. of floors in the basement	Bamboo <input type="checkbox"/>
3 <input type="checkbox"/>		Burnt Brick <input type="checkbox"/>
4 <input type="checkbox"/>	1 <input type="checkbox"/>	Stone <input type="checkbox"/>
>4 <input type="checkbox"/>	2 <input type="checkbox"/>	Cement <input type="checkbox"/>
	3 <input type="checkbox"/>	Mosaic/Floor tiles <input type="checkbox"/>
	>3 <input type="checkbox"/>	

4.8 Wall Details

Wall Material	Concrete	Burnt Brick	Unburnt Brick	Dressed Stone	Undressed Stone	Wood	Mud	Grass/thatch/bamboo	Plastic/Polythene
	<input type="checkbox"/>	<input type="checkbox"/>	<input type="checkbox"/>	<input type="checkbox"/>	<input type="checkbox"/>	<input type="checkbox"/>	<input type="checkbox"/>	<input type="checkbox"/>	<input type="checkbox"/>
For stone masonry, size of the stone >300 mm					Yes <input type="checkbox"/>	No <input type="checkbox"/>			
Ratio of wall length/ height and thickness									
Wall Types		Thickness of Wall (inch.)			Length of Wall Between Cross Wall (ft.)		Height of wall from floor to ceiling (ft.)		
Type 1									
Type 2									
Opening in any wall (for Masonry Construction)									
1 st Storey (>50%)					Yes <input type="checkbox"/>	No <input type="checkbox"/>			
2 nd Storey (>40%)					Yes <input type="checkbox"/>	No <input type="checkbox"/>			
3 rd storey and above (33%)					Yes <input type="checkbox"/>	No <input type="checkbox"/>			
Opening near the corner of the wall (<2 ft)					Yes <input type="checkbox"/>	No <input type="checkbox"/>			
Opening are too close to each other (<2 ft)					Yes <input type="checkbox"/>	No <input type="checkbox"/>			

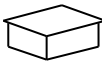
4.9 Roof Details

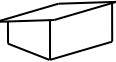
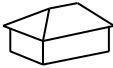
Roof type	Roofing Material	Truss	
Flat  <input type="checkbox"/>	Concrete <input type="checkbox"/>	If yes, Truss Material Yes <input type="checkbox"/>	
Open Gable  <input type="checkbox"/>	G.I., Metal, Asbestos sheet <input type="checkbox"/>		Steel <input type="checkbox"/>
Box Gable  <input type="checkbox"/>	Stone/ Slate <input type="checkbox"/>	No <input type="checkbox"/>	
Shed Roof  <input type="checkbox"/>	Wood <input type="checkbox"/>	Whether truss is anchored to the beam or wall: Yes <input type="checkbox"/>	
Hip Roof  <input type="checkbox"/>	Mud <input type="checkbox"/>		No <input type="checkbox"/>
Can't be specified <input type="checkbox"/>	Burnt Brick <input type="checkbox"/>		
	Tiles <input type="checkbox"/>		

	Thatch/ Bamboo <input type="checkbox"/>	
--	---	--

4.10 Materials Used in Mortar

Mud	<input type="checkbox"/>
Cement	<input type="checkbox"/>
No Mortar	<input type="checkbox"/>

Proportion of Mix	Cement <input type="checkbox"/> : Sand <input type="checkbox"/>
-------------------	---

4.11 Staircase:

4.11.1 Type of Staircase:

Separated <input type="checkbox"/>	Connected <input type="checkbox"/>	Enclosed <input type="checkbox"/>
------------------------------------	------------------------------------	-----------------------------------

4.11.2 Material of the staircase:

Brick <input type="checkbox"/>	Stone <input type="checkbox"/>	Wood <input type="checkbox"/>	Concrete <input type="checkbox"/>	Steel <input type="checkbox"/>
--------------------------------	--------------------------------	-------------------------------	-----------------------------------	--------------------------------

5. Present condition of the Building:

5.1 Is there any structural crack in the building? Yes No

5.2 If Yes,

Building Element	H		V		D	
	M1	M2	M1	M2	M1	M2
Beam	<input type="checkbox"/>	<input type="checkbox"/>	<input type="checkbox"/>	<input type="checkbox"/>	<input type="checkbox"/>	<input type="checkbox"/>
Column	<input type="checkbox"/>	<input type="checkbox"/>	<input type="checkbox"/>	<input type="checkbox"/>	<input type="checkbox"/>	<input type="checkbox"/>
Wall	<input type="checkbox"/>	<input type="checkbox"/>	<input type="checkbox"/>	<input type="checkbox"/>	<input type="checkbox"/>	<input type="checkbox"/>

Code: Type of Cracks : H= Horizontal ; V= Vertical ; D= Diagonal
Size of the Crack: M1= Minor (0-5mm) ; M2= Major (>5mm)

5.3 Type of Building Distress:

5.3.1 Wall:

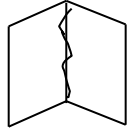
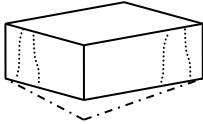
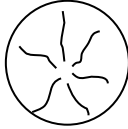
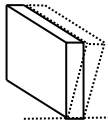
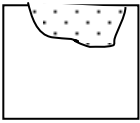
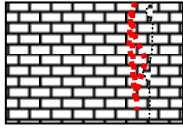
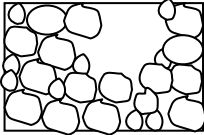
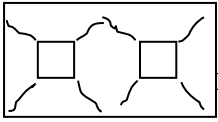
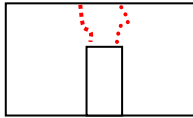
 <p>Corner crack in wall</p>	 <p>Settlement Crack</p>	 <p>Bulging</p>
 <p>Wall overturning</p>	 <p>Partial Wall Collapse</p>	 <p>Vertical Cracks in full depth of the wall</p>
 <p>Wythe Separation</p>	 <p>Diagonal Cracks near opening (door & window)</p>	 <p>Vertical cracks above door/ window</p>

5.3.2 Roof:

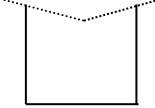
 <p>Roof Sag</p>	 <p>Roof Collapse</p>
--	---

5.3.3 Column:

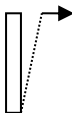
 <p>Shear Cracks in Column</p>	 <p>Column sway</p>
--	---

5.3.4 Beam:

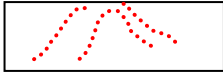
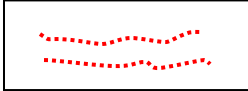
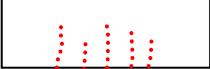
 <input type="checkbox"/>		 <input type="checkbox"/>
Shear cracks in the beam	Horizontal cracks in beam	Tensile cracks in the beam





5.4 Other deficient parameters:

Water Seepage	Corrosion	Quality of Construction	Quality of Concreting	Maintenance
Yes <input type="checkbox"/>	Yes <input type="checkbox"/>	Poor <input type="checkbox"/>	Poor <input type="checkbox"/>	Undertaken <input type="checkbox"/> Not Undertaken <input type="checkbox"/>
No <input type="checkbox"/>	No <input type="checkbox"/>	Moderate <input type="checkbox"/>	Moderate <input type="checkbox"/>	
	If Yes, severity of corrosion	Good <input type="checkbox"/>	Good <input type="checkbox"/>	
	Minor <input type="checkbox"/>			
	Acute <input type="checkbox"/>			

6. Vulnerability factors for specific hazard types:

6.1 Earthquake:

6.1.1 Shape of the Building:

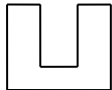
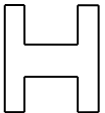
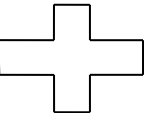
 <input type="checkbox"/>	 <input type="checkbox"/>	 <input type="checkbox"/>	 <input type="checkbox"/>
Rectangular	Circular	L Shape	T Shape
 <input type="checkbox"/>	 <input type="checkbox"/>	 <input type="checkbox"/>	None of the Above <input type="checkbox"/>
U Shape	H Shape	Plus Shape	

6.1.2 Vertical Irregularities:

Presence of setbacks	Yes <input type="checkbox"/>	No <input type="checkbox"/>
Presence of step back	Yes <input type="checkbox"/>	No <input type="checkbox"/>

6.1.3 Structural Irregularities:

Presence of different storey height	Presence of soft storey	Presence of short column	Presence of reentrant corners	Presence of Heavy Overhangs
Yes <input type="checkbox"/>	Yes <input type="checkbox"/>	Yes <input type="checkbox"/>	Yes <input type="checkbox"/>	Yes <input type="checkbox"/>
No <input type="checkbox"/>	No <input type="checkbox"/>	No <input type="checkbox"/>	No <input type="checkbox"/>	No <input type="checkbox"/>

6.1.4 Presence of Horizontal Band (Masonry Construction):

Horizontal Band at plinth level	Yes <input type="checkbox"/>	No <input type="checkbox"/>	Can't be identified <input type="checkbox"/>
Horizontal Band at lintel Level	Yes <input type="checkbox"/>	No <input type="checkbox"/>	Can't be identified <input type="checkbox"/>
Horizontal Band at sill Level	Yes <input type="checkbox"/>	No <input type="checkbox"/>	Can't be identified <input type="checkbox"/>
Horizontal Band at roof Level	Yes <input type="checkbox"/>	No <input type="checkbox"/>	Can't be identified <input type="checkbox"/>

6.1.5 Pounding:

Building Susceptibility of Pounding	Yes <input type="checkbox"/>	No <input type="checkbox"/>	
Apparent quality of adjacent building	Good <input type="checkbox"/>	Moderate <input type="checkbox"/>	Poor <input type="checkbox"/>

6.1.6 Falling Hazards:

Exterior Falling Hazards (Non anchored)	Parapets	Cladding	Chimney	Water tank	Heavy Machines/Generators	Communication Tower	Big Hoardings	Heavy Flower Pots	Car Parked on the top floor	Roof Top Garden	Air Conditioner Units
				Concrete							
	<input type="checkbox"/>	<input type="checkbox"/>	<input type="checkbox"/>	<input type="checkbox"/>	<input type="checkbox"/>	<input type="checkbox"/>	<input type="checkbox"/>	<input type="checkbox"/>	<input type="checkbox"/>	<input type="checkbox"/>	<input type="checkbox"/>

Interior Falling Hazards (Non anchored)	Heavy Furniture	Heavy Wall Hangings	Heavy Machines
	<input type="checkbox"/>	<input type="checkbox"/>	<input type="checkbox"/>

6.1.7 Frame Action:

Whether frames are orthogonal	Yes <input type="checkbox"/>	No <input type="checkbox"/>
Presence of Secondary Beams	Yes <input type="checkbox"/>	No <input type="checkbox"/>

6.1.8 Diaphragm Action:

Presence of Diaphragm Opening	Yes <input type="checkbox"/>	No <input type="checkbox"/>
Location of Opening	Corner <input type="checkbox"/>	Center <input type="checkbox"/>
Percentage of opening	< 50% <input type="checkbox"/>	≥ 50% <input type="checkbox"/>

6.2. Flood

Whether building floor is elevated above the ground level to prevent dampness or flooding	Have you been affected by flood?			
	Yes	<input type="checkbox"/>		
	No	<input type="checkbox"/>		
Yes <input type="checkbox"/> No <input type="checkbox"/>	If yes			
	Year of the event (YYYY)	Max. height of Inundation (ft.)	Duration (hrs)	Building Damage loss (INR)

6.3 Landslide:

Landslide history?	Year of the event (YYYY)	Building Damage Loss (INR)
Yes <input type="checkbox"/>		
No <input type="checkbox"/>		

6.4 Fire

Is Kitchen a separate unit in Home?	Any Historical event of fire?	Year of the Event (YYYY)	Cause of Fire	Building Damage Loss (INR)
Yes <input type="checkbox"/>	Yes <input type="checkbox"/>			
No <input type="checkbox"/>	No <input type="checkbox"/>			
Not Applicable <input type="checkbox"/>				

ANNEXURE 5: DATASHEET FOR ECONOMIC LOSS ESTIMATION

Investigator:

Date:

1. **Name of the Village:**

2. **Block:**

3. **District:**

4. **Latitude & Longitude:**

5. **Village Location:**
 - 5.a. **Plain/Hill slope/ Ridge:**
 - 5.b. **Altitude:**

6. **Distance & altitude from the road:**

7. **Building Material Prices:**

Item	Unit	Basic Cost (Rs.)	Transportation Cost (Rs.)
Earth			
Stone			
Aggregate			
Sand			
Lime			
Cement			
Burnt Brick			
Unburnt Brick			
Timber 1 (specify)			
Timber 2 (specify)			
Timber 3 (specify)			

Thatch			
Steel Rods (MS)			
Steel Rods (HYSD)			
Slate			
GI Sheet			
Asbestos Sheet			
GI Wire			
Structural Steel			

8. Labour rates:

Labour Rates (Daily)	Rs.	Availability (Yes/No)
Head Mason		
Mason		
Carpenter		
Bar Bender		
Labour (Male)		
Labour (Female)		

9. Cost of Construction (per square feet):

Annexure 6: Sample Of RVS Score Calculation For Each Building Typology

Performance score or RVS score mainly depends on soil type, building condition, architectural and earthquake resistance features. Other important data regarding the building is also gathered during the screening, including the occupancy of the building and the presence of non-structural falling hazards. In this, non-structural interior components are not evaluated.

Examples for calculation of performance score for all five major type of buildings are shown below:

Brick Masonry

RAPID VISUAL SURVEY OF MASONRY BUILDINGS FOR EARTHQUAKE SAFETY					SEISMIC ZONE	Zone V <input checked="" type="checkbox"/>
						Zone IV
						Zone II or III
Address/Location/Street <i>MEHAR SINGH BPO DHANOTU, SHANUR</i>			CITY <i>KANGRA</i>		FULL ACCESS <input checked="" type="checkbox"/>	
Year of construction <i>1970</i>			STATE <i>H.P.</i>		PARTIAL ACCESS	
Type of Construction	RC Frame	Brick Masonry <input checked="" type="checkbox"/>	Stone Masonry	Number of Floors <i>- 1</i>	NO ACCESS	
Use	Residential <input checked="" type="checkbox"/>	Commercial /Office	Mixed	Other	Please specify	
CHECKLIST OF OBSERVABLES IN MASONRY BUILDINGS				Tick	COMMENTS	
Structural Irregularities						
Lack of adequate walls in both orthogonal directions				<input checked="" type="checkbox"/>		
Heavy overhangs				<input checked="" type="checkbox"/>		
Reentrant Corners				<input checked="" type="checkbox"/>		
Corner buildings				<input checked="" type="checkbox"/>		
Apparent Quality						
Apparent quality of materials and construction				<input checked="" type="checkbox"/>		
Maintenance				<input checked="" type="checkbox"/>	<i>moderate</i>	
Soil Conditions				<input checked="" type="checkbox"/>	<i>medium</i>	
Pounding						
Contiguous buildings				<input checked="" type="checkbox"/>		
Poor apparent quality of adjacent buildings				<input checked="" type="checkbox"/>		
Openings						
Large openings in walls				<input checked="" type="checkbox"/>	<i>moderate Regular Opening</i>	
Irregularly placed openings				<input checked="" type="checkbox"/>		
Openings at corners of bearing wall intersections				<input checked="" type="checkbox"/>		
Diaphragm Action						
Evidence of absence of diaphragms				<input checked="" type="checkbox"/>		
Evidence of large cut outs in diaphragms				<input checked="" type="checkbox"/>		
Other features						
Horizontal bands at plinth level				<input checked="" type="checkbox"/>	<i>Band at Lintel and Plinth level present</i>	
Horizontal bands at lintel level				<input checked="" type="checkbox"/>		
Horizontal bands at sill level				<input checked="" type="checkbox"/>		
Horizontal band at roof level				<input checked="" type="checkbox"/>		
Arches present/absent				<input checked="" type="checkbox"/>		
Jack Arch roofs				<input checked="" type="checkbox"/>		
Stone/masonry chimneys				<input checked="" type="checkbox"/>		
Random rubble stone masonry walls						
Presence of thick walls 600mm and above				...		
Use of rounded stones				...		
Heavy roofs on URRM walls				...		
Falling Hazards						
Non-structural elements such as elaborate parapets, AC unit grilles, elevation features, advertisement hoardings, roof signs, marquees, etc.				<input checked="" type="checkbox"/>		
ANY OTHER SPECIAL FEATURES						

Figure 1
(a).

Proforma for Brick Masonry Buildings (First page)

RAPID VISUAL SURVEY OF MASONRY BUILDINGS FOR EARTHQUAKE SAFETY					CALCULATION SHEET MASONRY				
FALLING HAZARDS IDENTIFIER 'F'					Seismic Zone			Base Score	
Marquees/Hoardings/Roof Signs	x				Stories	V ✓	IV	III-II	
AC Units/Grillework	x				1 or 2 ✓	100	130	150	
Elaborate parapets	x				3	85	110	125	
Heavy elevation features	x				4	70	90	110	
Heavy Canopies	x				5	50	60	70	
Substantial Balconies	x								
Heavy Cladding	x								
Structural Glazing	x								
Number of storeys	1 or 2	3	4	5	Vulnerability Score Modifiers				
Vulnerability Scores (VS)					(VSM)			(VS X VSM)	
Structural Irregularity	-10	-10	-10	-10	Doesn't exist/unsure=0 ✓			0	
					Exists=1				
Apparent Quality	-10	-10	-10	-10	Good=0				
					Moderate=1 ✓			-10	
					Poor=2				
Soil Conditions	10	10	10	10	Medium=0 ✓			0	
					Hard=1				
					Soft=-1				
Pounding	0	-3	-5	-5	Doesn't exist=0 ✓			0	
					Normal apparent condition of adjacent building=1				
					Poor apparent condition of adjacent building=2				
Openings									
Wall openings	-5	-5	-5	-5	Small (less than 1/3) = 0				
					Moderate (Between 1/3 and 2/3) = 1 ✓			-5	
					Large (Above 2/3) = 2				
Orientation of openings	-2	-5	-5	-5	Regular = 0 ✓			0	
					Irregular = 1				
Diaphragm Action	-10	-15	-15	-15	Present/Unsure=0 ✓			0	
					Lack of diaphragm action=1				
Other Features									
Horizontal Bands	20	20	20	20	Exist =+1 ✓			20	
					Don't exist=0				
Arches	-10	-10	-10	-10	Exist=1			0	
					Doesn't exist/unsure=0				
Stone Masonry									
Random Rubble Stone Masonry Walls	-15	-15	-15	-15	Remedial measures exist= 0				
					Don't exist = 1			15	
∑ [(VSM) x (VS)]								+5	
Performance Score= (BS) + ∑ [(VSM) x (VS)] where VSM represents the vulnerability score modifiers and VS represents the Vulnerability Score that is multiplied with VSM to obtain the actual modifier to be applied to the Basic Score (BS).						Performance Score		105	
Field Survey by: <i>hugan</i>				Reviewed by: <i>newdof</i>				Approved by:	
Date: 17/12/13				Date: 18/12/13				Date:	

Figure 1 (b). Proforma for Brick Masonry Buildings (Second page)

Hybrid Buildings

RAPID VISUAL SURVEY OF HYBRID BUILDINGS FOR EARTHQUAKE SAFETY				SEISMIC ZONE		Zone V <input checked="" type="checkbox"/>
						Zone IV
						Zone II and III
Address/Location/Street <i>Shimla</i>			CITY <i>Shimla</i>		FULL ACCESS	
Year of construction			STATE <i>HP</i>		PARTIAL ACCESS <input checked="" type="checkbox"/>	
Type of Construction	RC Frame	Masonry	<input checked="" type="checkbox"/> Hybrid	Number of Floors		NO ACCESS
Use	<input checked="" type="checkbox"/> Residential	Commercial /Office	Mixed	Other	Please specify	
CHECKLIST OF OBSERVABLES				COMMENTS		
Soft Storey Open parking at ground level Absence of partition walls in ground or any intermediate storey for shops or other commercial use Taller heights in ground or any other intermediate storey				No NO NO		
Vertical irregularities Presence of setbacks Building on slopy ground				NO NO		
Plan irregularities Irregular plan configuration Reentrant corners				No Yes		
Heavy Overhangs Moderate horizontal projections Substantial horizontal projections				NO		
Apparent Quality Apparent quality of materials and construction Maintenance				Poor		
Short Column				NO		
Pounding				Yes		
Soil Condition				Poor		
Hybrid Action				Yes		
Falling Hazards Non-structural elements such as elaborate parapets, AC unit grilles, elevation features				NO		
PICTURES/SKETCHES						
 <p style="text-align: center;">3D View</p>						

Figure 2 (a). Proforma for Hybrid Buildings (First page)

RAPID VISUAL SURVEY OF HYBRID BUILDINGS FOR EARTHQUAKE SAFETY						CALCULATION SHEET FOR HYBRID			Base Score
Falling Hazard Identifier 'F'						Seismic Zone			
Marqueses/Hoardings/Roof Signs						V	IV	III-II	90
AC Units/Grill work						100	130	150	
Elaborate parapets						90	120	140	
Heavy elevation features						75	100	120	
Heavy Canopies						65	85	100	
Substantial Balconies						60	80	90	
Heavy Cladding									
Structural Glazing									
Number of storeys		2	3	4	5	> 5	Vulnerability Score Modifiers		
Vulnerability Scores (VS)						(VSM)			(VS X VSM)
Soft Story		-5	-5	-5	-5	-5	Doesn't exist=0 ✓	Exists=1	0
Vertical irregularities		-2	-2	-2	-2	-2	Doesn't exist=0 ✓	Exists=1	0
Setbacks		-2	-2	-2	-2	-2	None=0 ✓	Moderate=1	0
Buildings on Slopes		-1	-1	-1	-1	-1	Extreme=2		
Plan irregularities		-1	-1	-1	-1	-1	Doesn't exist=0 ✓	Exists=1	0
Heavy Overhangs		-2	-3	-3	-4	-5	Good=0	Moderate=1	-20
Apparent quality		-5	-10	-10	-15	-15	Poor=2 ✓		
Short columns		-3	-3	-3	-3	-3	Doesn't exist=0 ✓	Exists=1	0
Pounding		0	-2	-3	-3	-3	Doesn't exist=0	Unaligned floors=2	-4
Soil Condition		-3	-3	-3	-3	-3	Poor apparent quality of adjacent building=2	Medium=0 ✓	
Frame Action		10	10	10	10	10	Hard=1	Soft=-1	-10
Hybrid Action		-2	-2	-2	-2	-2	Doesn't exist=-1 ✓	Exists=+1	
							Not sure=0	Doesn't exist=-1	2
							Exists=+1 ✓	Not sure=0	
						∑ [(VSM) x (VS)]			-32
Performance Score= (BS) - ∑ [(VSM) x (VS)]						Performance Score			90 - 32 = 58
where VSM represents the vulnerability score modifiers and VS represents the Vulnerability Score that is multiplied with VSM to obtain the actual modifier to be applied to the Basic Score (BS).						Approved by:			
Field Survey by:			Reviewed by:			Date:			
Date:			Date:			Date:			

Figure 2 (b). Proforma for Hybrid Buildings (Secondpage)

RC Frame Building

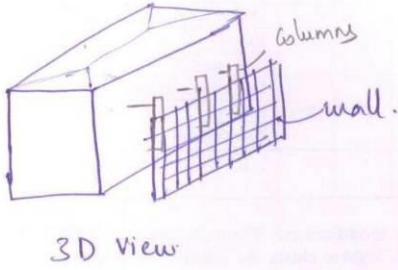
RAPID VISUAL SURVEY OF RC FRAME BUILDINGS FOR EARTHQUAKE SAFETY				SEISMIC ZONE	
Address/Location/Street: <i>JR MODEL SCHOOL MEHATPUR,</i>				Zone V	
				Zone IV <input checked="" type="checkbox"/>	
				Zone II and III	
Year of construction: <i>2007</i>				CITY: <i>UNA</i>	
				STATE: <i>H.P.</i>	
Type of Construction		RC Frame <input checked="" type="checkbox"/> Masonry <input checked="" type="checkbox"/>		Number of Floors: <i>2</i>	
Use		Residential <input type="checkbox"/> Commercial/Office <input checked="" type="checkbox"/> Mixed <input type="checkbox"/>		Other <input type="checkbox"/> Please specify: <i>EDUCATIONAL</i>	
CHECKLIST OF OBSERVABLES				COMMENTS	
Soft Storey Open parking at ground level <input checked="" type="checkbox"/> Absence of partition walls in ground or any intermediate storey for shops or other commercial use <input checked="" type="checkbox"/> Taller heights in ground or any other intermediate storey <input checked="" type="checkbox"/>					
Vertical irregularities Presence of setbacks <input checked="" type="checkbox"/> Building on slopy ground <input checked="" type="checkbox"/>				—	
Plan irregularities Irregular plan configuration <input checked="" type="checkbox"/> Reentrant corners <input checked="" type="checkbox"/>				<i>C Shape PRESENT</i>	
Heavy Overhangs Moderate horizontal projections <input checked="" type="checkbox"/> Substantial horizontal projections					
Apparent Quality Apparent quality of materials and construction Maintenance				<i>POOR</i>	
Short Column					
Pounding				—	
Soil Condition				<i>Medium</i>	
Frame Action				<i>Not present</i>	
Falling Hazards Non-structural elements such as elaborate parapets, AC unit grilles, elevation features				—	
PICTURES/SKETCHES					

Figure 3 (a). Proforma for Reinforced Concrete Buildings (First page)

RAPID VISUAL SURVEY OF BUILDINGS FOR EARTHQUAKE SAFETY						CALCULATION SHEET RC FRAME				
Falling Hazard Identifier 'F'						Seismic Zone			Base Score	
Marquees/Hoardings/Roof Signs				Stories		V	IV ✓	III-II		
AC Units/Grillework			X	1 or 2 ✓		100	130	150	130	
Elaborate parapets				3		90	120	140		
Heavy elevation features			X	4		75	100	120		
Heavy Canopies			X	5		65	85	100		
Substantial Balconies			X	> 5		60	80	90		
Heavy Cladding			X							
Structural Glazing			X							
Number of storeys		1 or 2 ✓	3	4	5	> 5	Vulnerability Score Modifiers			
Vulnerability Scores (VS)						(VSM)			(VS X VSM)	
Soft Story		0	-15	-20	-25	-30	Doesn't exist=0 ✓			0
						Exists=1				
Vertical irregularities		-10	-10	-10	-10	-10	Doesn't exist=0 ✓			0
Setbacks							Exists=1			
Buildings on Slopes							None=0			
Plan irregularities		-5	-5	-5	-5	-5	Moderate=1 ✓			-5
						Extreme=2				
Heavy Overhangs		-5	-10	-10	-15	-15	Doesn't exist=0			-5
						Exists=1 ✓				
Apparent quality		-5	-10	-10	-15	-15	Good=0			-10
						Moderate=1				
						Poor=2 ✓				
Short columns		-5	-5	-5	-5	-5	Doesn't exist=0 ✓			0
						Exists=1				
Pounding		0	-2	-3	-3	-3	Doesn't exist=0 ✓			0
						Unaligned floors=2				
						Poor apparent quality of adjacent building=2				
Soil Condition		10	10	10	10	10	Medium=0 ✓			0
						Hard=1				
						Soft=-1				
Frame Action		10	10	10	10	10	Doesn't exist=-1 ✓			-10
						Exists=+1				
						Not sure=0				
						Σ [(VSM) x (VS)]			-30	
Performance Score = (BS) + Σ [(VSM) x (VS)]								Performance Score	100	
where VSM represents the vulnerability score modifiers and VS represents the Vulnerability Score that is multiplied with VSM to obtain the actual modifier to be applied to the Basic Score (BS).										
Field Survey by: <i>Surajit</i>				Reviewed by: <i>Neeraj</i>				Approved by:		
Date: <i>19-12-13</i>				Date: <i>20/12/2013</i>				Date:		

Figure 3 (b). Proforma for Reinforced Concrete Buildings (Second page)

Rammed Earth Building

RAPID VISUAL SURVEY OF RAMMED EARTH BUILDINGS FOR EARTHQUAKE SAFETY				SEISMIC ZONE	
				Zone V <input checked="" type="checkbox"/>	
				Zone IV <input type="checkbox"/>	
				Zone II or III <input type="checkbox"/>	
Address/Location/Street <i>New Shimla</i>		CITY <i>Shimla</i>		FULL ACCESS <input checked="" type="checkbox"/>	
Year of construction <i>-</i>		STATE <i>Himachal Pradesh</i>		PARTIAL ACCESS <input type="checkbox"/>	
Type of Construction	<i>Rammed Earth</i>	Brick Masonry	Stone Masonry	Number of Floors <i>2</i>	NO ACCESS <input type="checkbox"/>
Use	<input checked="" type="checkbox"/> Residential	<input type="checkbox"/> Commercial /Office	<input type="checkbox"/> Mixed	Other	Please specify <i>-</i>
CHECKLIST OF OBSERVABLES IN RAMMED EARTH BUILDINGS			Tick	COMMENTS	
Structural Irregularities					
Lack of adequate walls in both orthogonal directions			...		<i>No</i>
Reentrant Corners			...		<i>Yes</i>
Corner buildings			...		<i>No</i>
Apparent Quality					
Apparent quality of materials and construction			...		<i>Poor</i>
Maintenance			...		<i>Poor</i>
Soil Conditions			...		<i>Medium</i>
Plan to Cross Sectional Area			...		
Openings					
Large openings in walls			...		<i>No</i>
Irregularly placed openings			...		<i>No</i>
Openings at corners of bearing wall intersections			...		<i>No</i>
Diaphragm Action					
Evidence of absence of diaphragms			...		<i>Yes</i>
Evidence of large cut outs in diaphragms			...		<i>-</i>
Other features					
Horizontal bands at plinth level			...		<i>Yes (wooden)</i>
Horizontal bands at lintel level			...		<i>Yes (wooden)</i>
Horizontal bands at sill level			...		<i>Yes (wooden)</i>
Horizontal band at roof level			...		<i>Yes (wooden)</i>
Arches present/absent			...		<i>NO</i>
Jack Arch roofs			...		<i>NO</i>
Stone/masonry chimneys			...		<i>NO</i>
Random rubble stone masonry walls					
Presence of thick walls 600mm and above			...		<i>Yes</i>
Use of rounded stones			...		<i>Yes</i>
Heavy roofs on stone Masonry walls			...		<i>NO</i>
Falling Hazards					
Non-structural elements such as elaborate parapets, AC unit grilles, elevation features, advertisement hoardings, roof signs, marquees, etc.			...		<i>NO</i>
ANY OTHER SPECIAL FEATURES					

Figure 4 (a). Proforma for Rammed Earth Buildings (First page)

RAPID VISUAL SURVEY OF RAMMED EARTH BUILDINGS FOR EARTHQUAKE SAFETY					CALCULATION SHEET FOR RAMMED EARTH				
FALLING HAZARDS IDENTIFIER 'F'					Seismic Zone			Base Score	
					Stories	V ✓	IV	III-II	100
					1 or 2 ✓	100	130	150	
					3	85	110	125	
					4	70	90	110	
					5	50	60	70	
Number of storeys	1 or 2	3	4	5	Vulnerability Score Modifiers				
Vulnerability Scores (VS)					(VSM)			(VS X VSM)	
Structural Irregularity	-10	-10	-10	-10	Doesn't exist/unsure=0			-10	
					Exists=1 ✓				
Apparent Quality	-10	-10	-10	-10	Good=0			-20	
					Moderate=1				
					Poor=2 ✓				
Soil Conditions	10	10	10	10	Medium=0 ✓			0	
					Hard=1				
					Soft=-1				
Openings									
Wall openings	-5	-5	-5	-5	Small (less than 1/3) = 0			-5	
					Moderate (Between 1/3 and 2/3) = 1 ✓				
					Large (Above 2/3) = 2				
Orientation of openings	-2	-5	-5	-5	Regular = 0 ✓			0	
					Irregular = 1				
Diaphragm Action	-10	-15	-15	-15	Present/Unsure=0 ✓			0	
					Lack of diaphragm action=1				
Other Features									
Horizontal Bands	20	20	20	20	Exist =+1 ✓			20	
					Don't exist=0				
Arches	-10	-10	-10	-10	Exist=1			0	
					Doesn't exist/unsure=0 ✓				
Rammed Earth									
Random Rubble Stone Masonry Walls	-15	-15	-15	-15	Remedial measures exist= 0 ✓			0	
					Don't exist = 1				
$\Sigma [(VSM) \times (VS)]$								-15	
Performance Score= (BS) + $\Sigma [(VSM) \times (VS)]$ where VSM represents the vulnerability score modifiers and VS represents the Vulnerability Score that is multiplied with VSM to obtain the actual modifier to be applied to the Basic Score (BS).					Performance Score		100+(-15) = 85		
Field Survey by: <u>Ajay Kumar</u>				Reviewed by:		Approved by:			
Date: <u>18/12/2013</u>				Date:		Date:			

Figure 4 (b). Proforma for Rammed Earth Buildings (Second page)

Stone Masonry



RAPID VISUAL SURVEY OF STONE MASONRY BUILDINGS FOR EARTHQUAKE SAFETY					SEISMIC ZONE	
					Zone V <input checked="" type="checkbox"/>	
					Zone IV	
					Zone II or III	
Address/Location/Street <i>Dhasmshala</i>			CITY <i>Kargua</i>		FULL ACCESS <input checked="" type="checkbox"/>	
Year of construction			STATE <i>HP</i>		PARTIAL ACCESS	
Type of Construction	RC Frame	Brick Masonry	Stone Masonry <input checked="" type="checkbox"/>	Number of Floors <i>2</i>		NO ACCESS
Use	Residential	Commercial /Office <input checked="" type="checkbox"/>	Mixed	Other	Please specify	
CHECKLIST OF OBSERVABLES IN MASONRY BUILDINGS				Tick	COMMENTS	
Structural Irregularities						
Lack of adequate walls in both orthogonal directions				...	No	
Heavy overhangs				...	No	
Reentrant Corners				...	Yes	
Corner buildings				...	No	
Apparent Quality						
Apparent quality of materials and construction				...	Medium	
Maintenance				...	Medium	
Soil Conditions				...	Medium	
Pounding						
Contiguous buildings				...	No	
Poor apparent quality of adjacent buildings				...		
Openings						
Large openings in walls				...	No	
Irregularly placed openings				...	No	
Openings at corners of bearing wall intersections				...	No	
Diaphragm Action						
Evidence of absence of diaphragms				...	No	
Evidence of large cut outs in diaphragms				...	-	
Other features						
Horizontal bands at plinth level				...	Yes	
Horizontal bands at lintel level				...	Yes	
Horizontal bands at sill level				...	Yes	
Horizontal band at roof level				...	Yes	
Arches present/absent				...	No	
Jack Arch roofs				...	No	
Stone/masonry chimneys				...	No	
Random rubble stone masonry walls						
Presence of thick walls 600mm and above				...	Yes	
Use of rounded stones				...	No	
Heavy roofs on stone Masonry walls				...	No	
Falling Hazards						
Non-structural elements such as elaborate parapets, AC unit grilles, elevation features, advertisement hoardings, roof signs, marquees, etc.				...	Yes	
ANY OTHER SPECIAL FEATURES						
<div style="display: flex; justify-content: space-around; align-items: center;"> <div style="text-align: center;">  <p><i>Elevation</i></p> </div> <div style="text-align: center;">  <p><i>Plan</i></p> </div> </div>						

Figure 5 (a). Proforma for Stone Masonry Buildings (Firstpage)

RAPID VISUAL SURVEY OF MASONRY BUILDINGS FOR EARTHQUAKE SAFETY					CALCULATION SHEET MASONRY				
FALLING HAZARDS IDENTIFIER 'F'					Seismic Zone			Base Score	
Marquees/Hoardings/Roof Signs				Stories	V ✓	IV	III-II	100	
AC Units/Grillework	✓			1 or 2 ✓	100	130	150		
Elaborate parapets	—			3	85	110	125		
Heavy elevation features	✓			4	70	90	110		
Heavy Canopies	—			5	50	60	70		
Substantial Balconies	—								
Heavy Cladding	—								
Structural Glazing	✓								
Number of storeys	(1 or 2)	3	4	5	Vulnerability Score Modifiers (VSM)			(VS X VSM)	
Vulnerability Scores (VS)					Doesn't exist/unsure=0 ✓			0	
Structural Irregularity	-10	-10	-10	-10	Exists=1				
Apparent Quality	-10	-10	-10	-10	Good=0			-10	
					Moderate=1 ✓				
					Poor=2				
Soil Conditions	10	10	10	10	Medium=0 ✓			0	
					Hard=1				
					Soft=-1				
Pounding	0	-3	-5	-5	Doesn't exist=0 ✓			0	
					Normal apparent condition of adjacent building=1				
					Poor apparent condition of adjacent building=2				
Openings					Small (less than 1/3) = 0 ✓			0	
Wall openings	-5	-5	-5	-5	Moderate (Between 1/3 and 2/3) = 1			0	
					Large (Above 2/3) = 2				
					Regular = 0 ✓				
Orientation of openings	-2	-5	-5	-5	Irregular = 1			0	
					Present/Unsure=0 ✓				
Diaphragm Action	-10	-15	-15	-15	Lack of diaphragm action=1			0	
Other Features					Exist =+1 ✓			20	
Horizontal Bands	20	20	20	20	Don't exist=0			0	
					Exist=1				
Arches	-10	-10	-10	-10	Doesn't exist/unsure=0 ✓			0	
Stone Masonry					Remedial measures exist= 0 ✓			0	
Random Rubble Stone Masonry Walls	-15	-15	-15	-15	Don't exist = 1			0	
∑ [(VSM) x (VS)]							10		
Performance Score = (BS) - ∑ [(VSM) x (VS)] where VSM represents the vulnerability score modifiers and VS represents the Vulnerability Score that is multiplied with VSM to obtain the actual modifier to be applied to the Basic Score (BS).							Performance Score	100 + 10 = 110	
Field Survey by:				Reviewed by:				Approved by:	
Date:				Date:				Date:	

Figure 5 (b). Proforma for Stone Masonry Buildings (Second page)

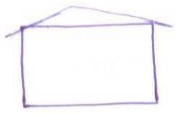
Annexure 7: Number of Buildings Damaged under Predominant Building Typology due to Earthquake of different Return Period

